

CF 16 VUU-AB JNS

Cam followers

TYPE: Roller bearings, Stud type track rollers, With axial guidance, full complement bearing, sealing rings on both sides, cylindrical outer ring, double hex hole

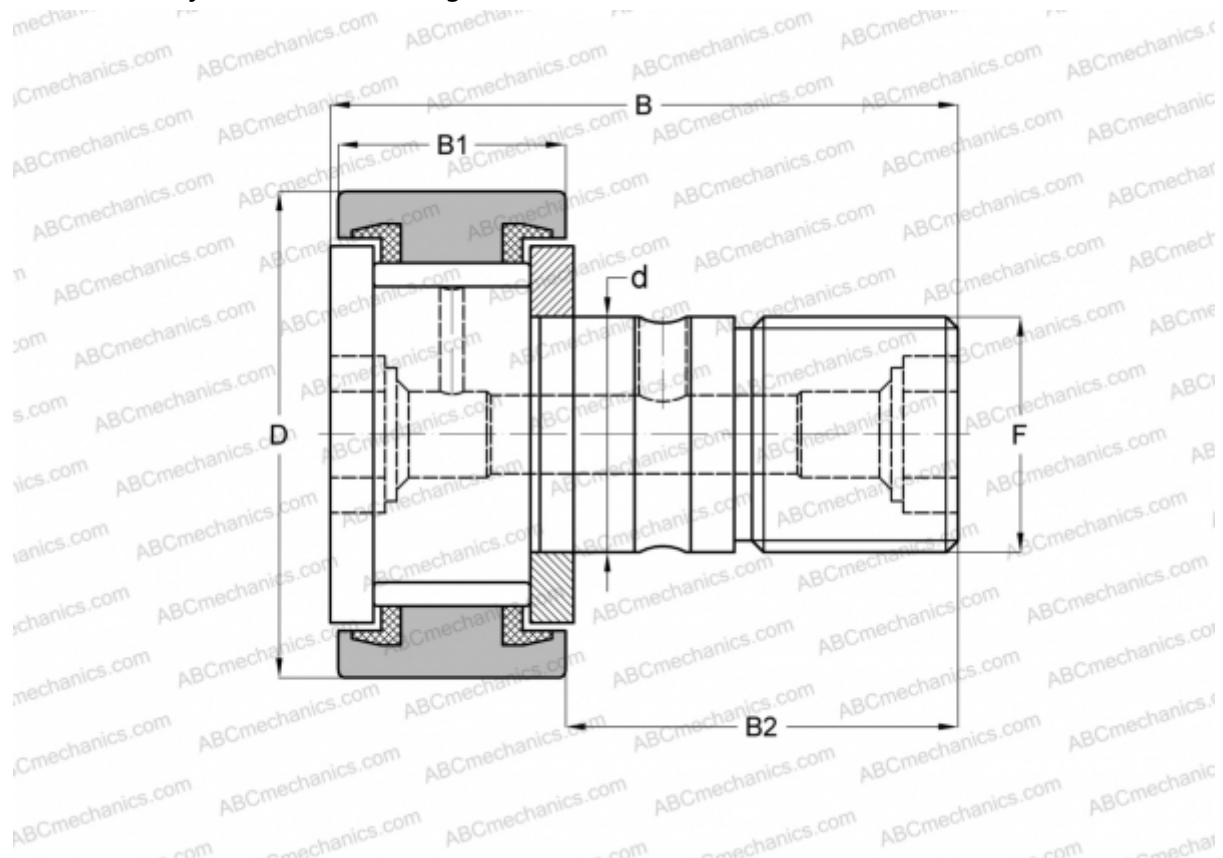

Technical specification

DIMENSIONS, MM

d	16,000
D	35,000
B	52,000
B1	18,000
B2	32,500
F	M16x1.5

WEIGHT, KG 0,177

MANUFACTURER [JNS](#)

INTERCHANGE

ABC	CFKR 35 VUU
IKO	CFKR 35 VUU
THK	CF 16 VUU-AB