

CFKR 52 VUU IKO

Cam followers

TYPE: Roller bearings, Stud type track rollers, With axial guidance, full complement bearing, sealing rings on both sides, cylindrical outer ring, double hex hole

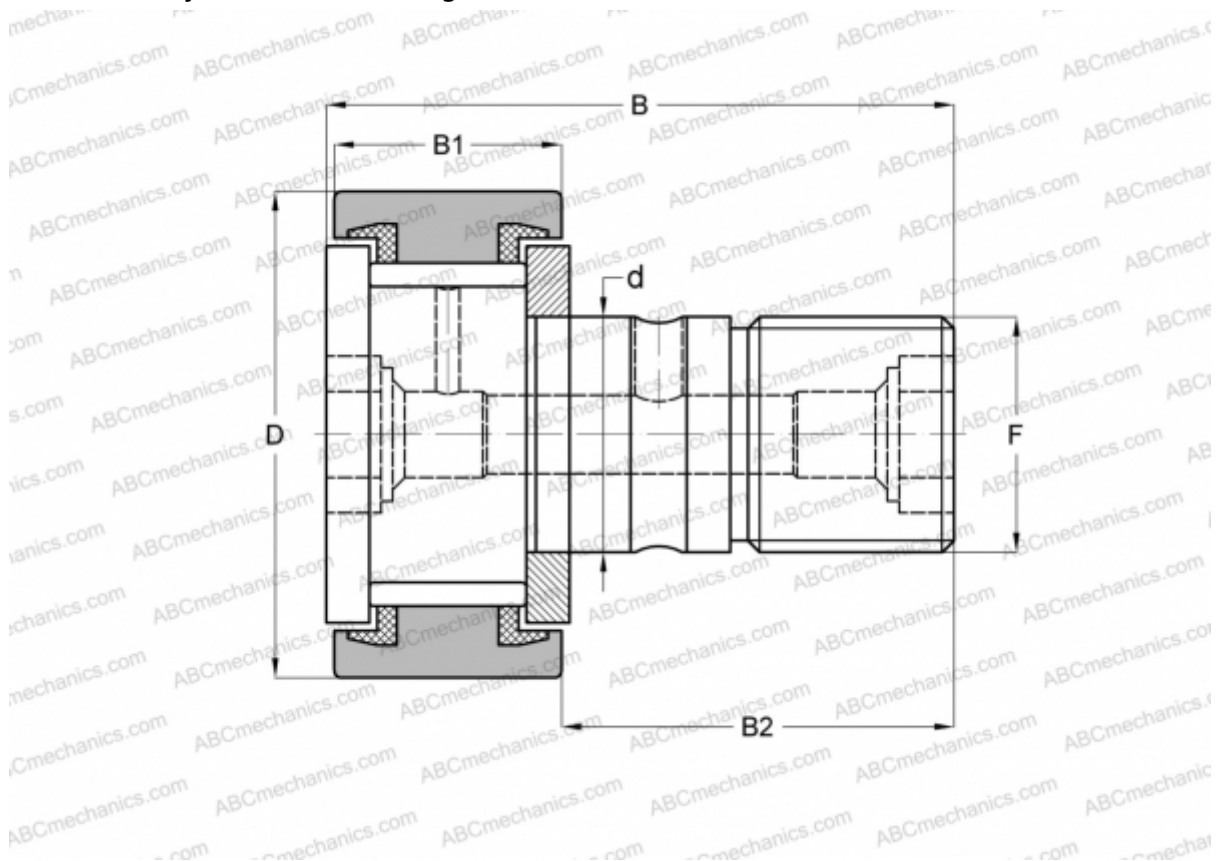

Technical specification

DIMENSIONS, MM

d	20,000
D	52,000
B	66,100
B1	24,000
B2	40,500
F	M20x1.5

WEIGHT, KG 0,458

MANUFACTURER [IKO](#)

INTERCHANGE

ABC	CFKR 52 VUU
JNS	CF 20 VUU-AB
THK	CF 20 VUU-AB

CALCULATION DATA

Basic dynamic load rating, C	33,200 kN
Basic static load rating, Co	64,500 kN