

## CF 20 VUU-AB THK

Cam followers

TYPE: Roller bearings, Stud type track rollers, With axial guidance, full complement bearing, sealing rings on both sides, cylindrical outer ring, double hex hole

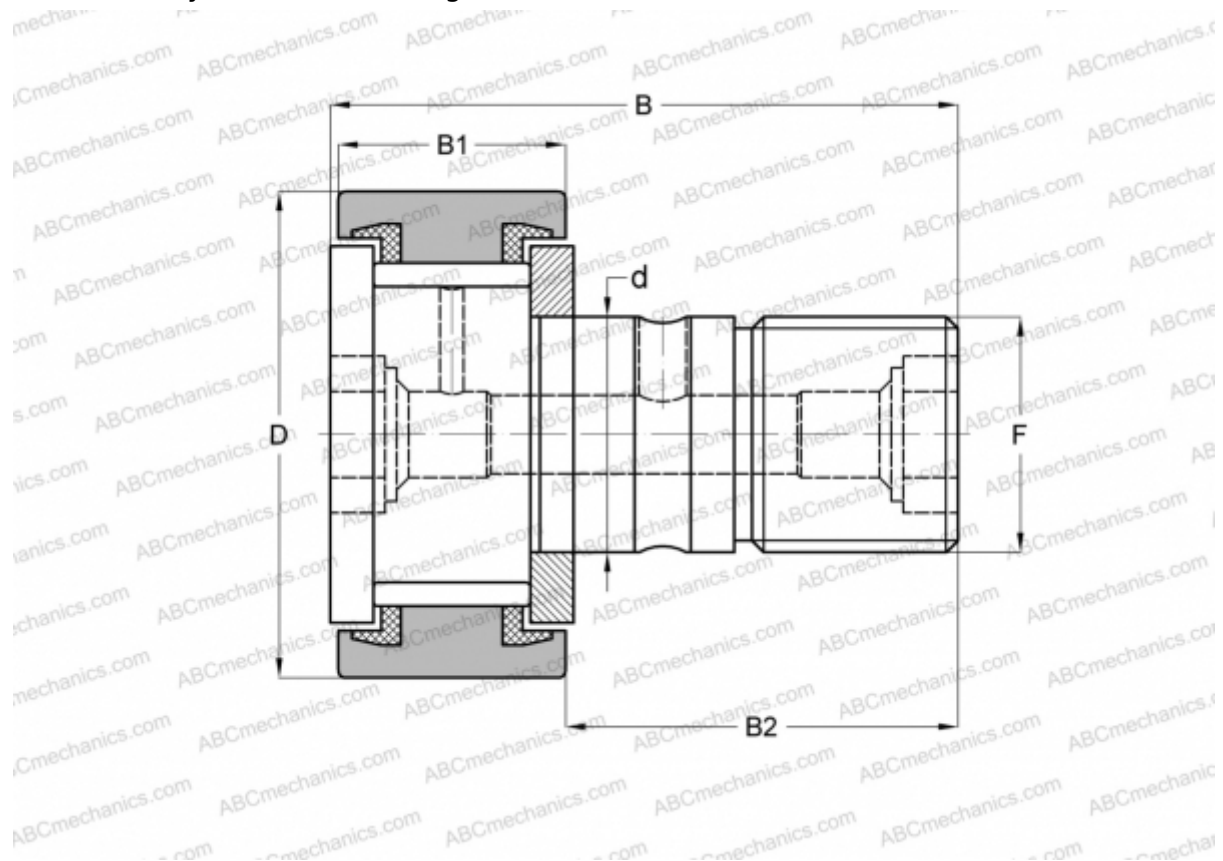

### Technical specification

#### DIMENSIONS, MM

d	20,000
D	52,000
B	66,000
B1	24,000
B2	40,500
F	M20x1.5

**WEIGHT, KG** 0,473

**MANUFACTURER** [THK](#)

#### INTERCHANGE

ABC	<a href="#">CFKR 52 VUU</a>
IKO	<a href="#">CFKR 52 VUU</a>
JNS	<a href="#">CF 20 VUU-AB</a>