

CF 8 VB IKO

Cam followers

TYPE: Roller bearings, Stud type track rollers, With axial guidance, full complement bearing, gap seal on both side, cylindrical outer ring, hex socket

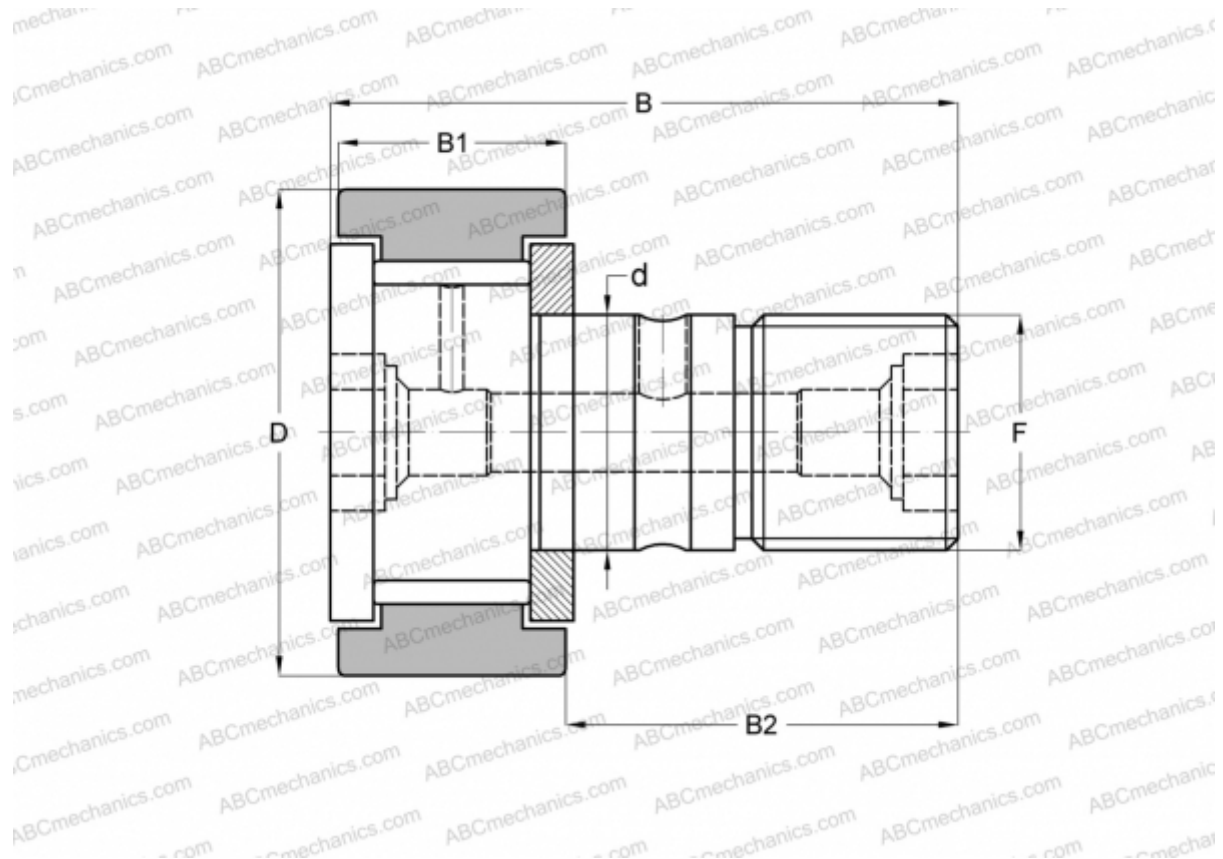

Technical specification

DIMENSIONS, MM

d	8,000
D	19,000
B	32,200
B1	11,000
B2	20,000
F	M8x1.25

WEIGHT, KG 0,029

MANUFACTURER [IKO](#)

INTERCHANGE

ABC	CF 8 VB
INA	KRV 19 XSK
SKF	KRV 19 XSK
McGill	MCF-19-BX

CALCULATION DATA

Basic dynamic load rating, C	8,170 kN
Basic static load rating, Co	11,200 kN