

MCF-32-BX McGill

Cam followers

TYPE: Roller bearings, Stud type track rollers, With axial guidance, full complement bearing, gap seal on both side, cylindrical outer ring, hex socket

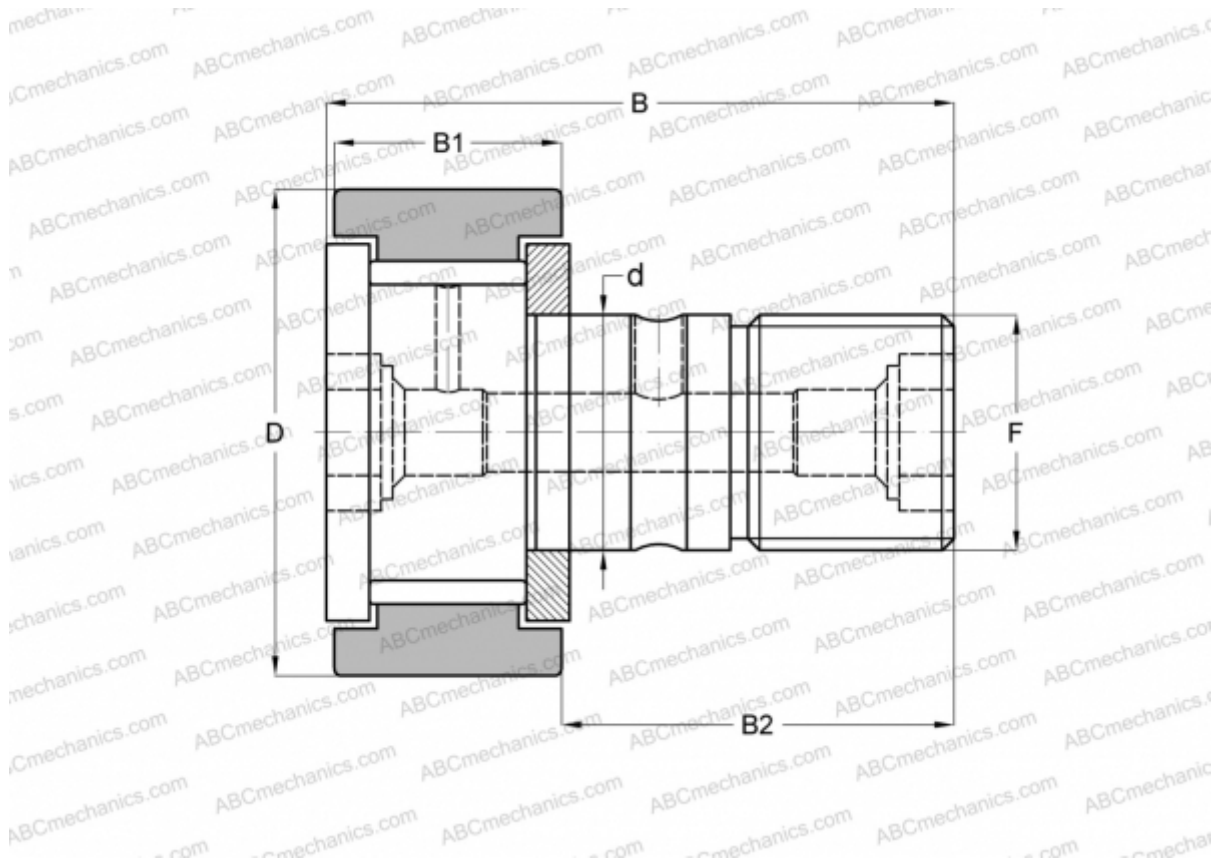

Technical specification

DIMENSIONS, MM

d	12,000
D	32,000
B	40,200
B1	14,000
B2	25,000
F	M12x1.5

WEIGHT, KG 0,107

MANUFACTURER [McGill](#)

INTERCHANGE

ABC	CF 12-1 VB
IKO	CF 12-1 VB
INA	KRV 32 XSK
SKF	KRV 32 XSK