

## MCF-40-BX McGill

Cam followers

TYPE: Roller bearings, Stud type track rollers, With axial guidance, full complement bearing, gap seal on both side, cylindrical outer ring, hex socket

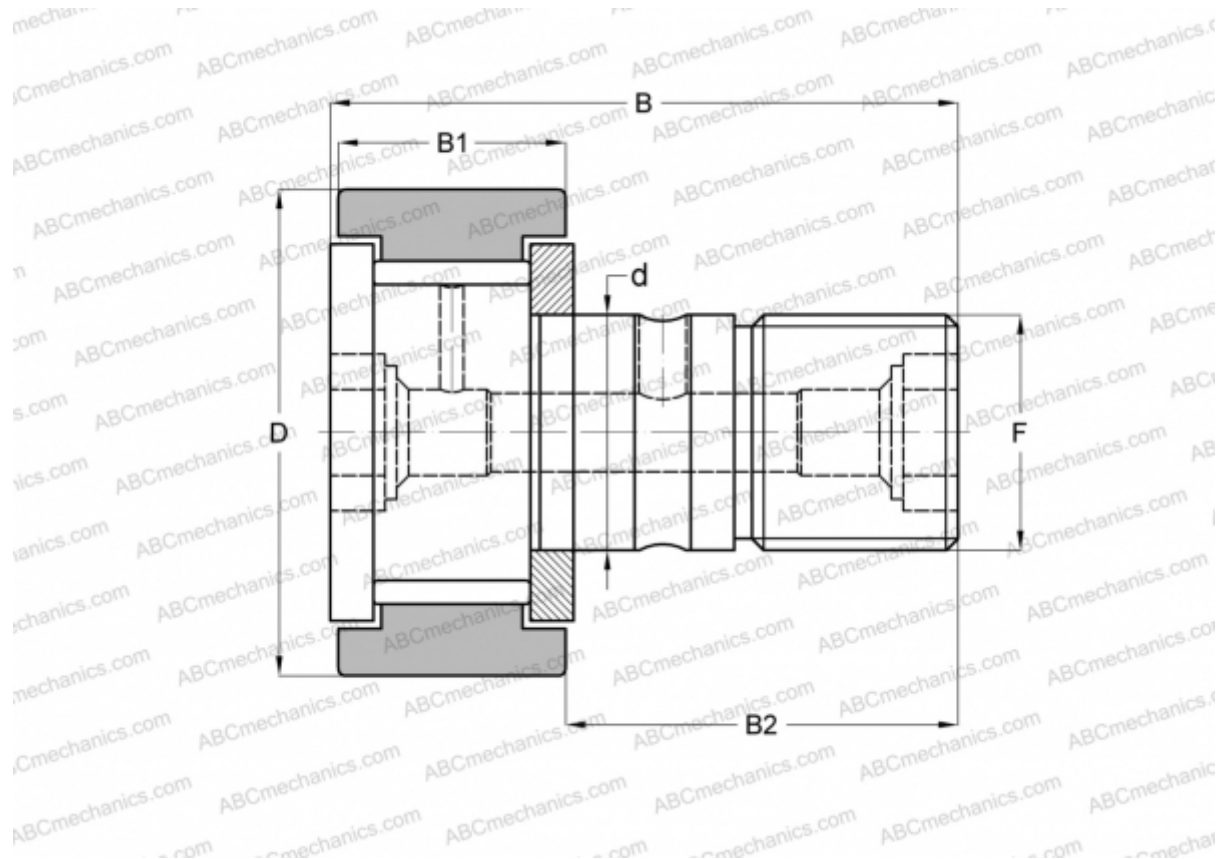

### Technical specification

#### DIMENSIONS, MM

d	18,000
D	40,000
B	58,100
B1	20,000
B2	36,500
F	M18x1.5

**WEIGHT, KG** 0,255

**MANUFACTURER** [McGill](#)

#### INTERCHANGE

ABC	<a href="#">CF 18 VB</a>
IKO	<a href="#">CF 18 VB</a>
INA	<a href="#">KRV 40 XSK</a>
SKF	<a href="#">KRV 40 XSK</a>