

KRV 52 XSK INA

Cam followers

TYPE: Roller bearings, Stud type track rollers, With axial guidance, full complement bearing, gap seal on both side, cylindrical outer ring, hex socket

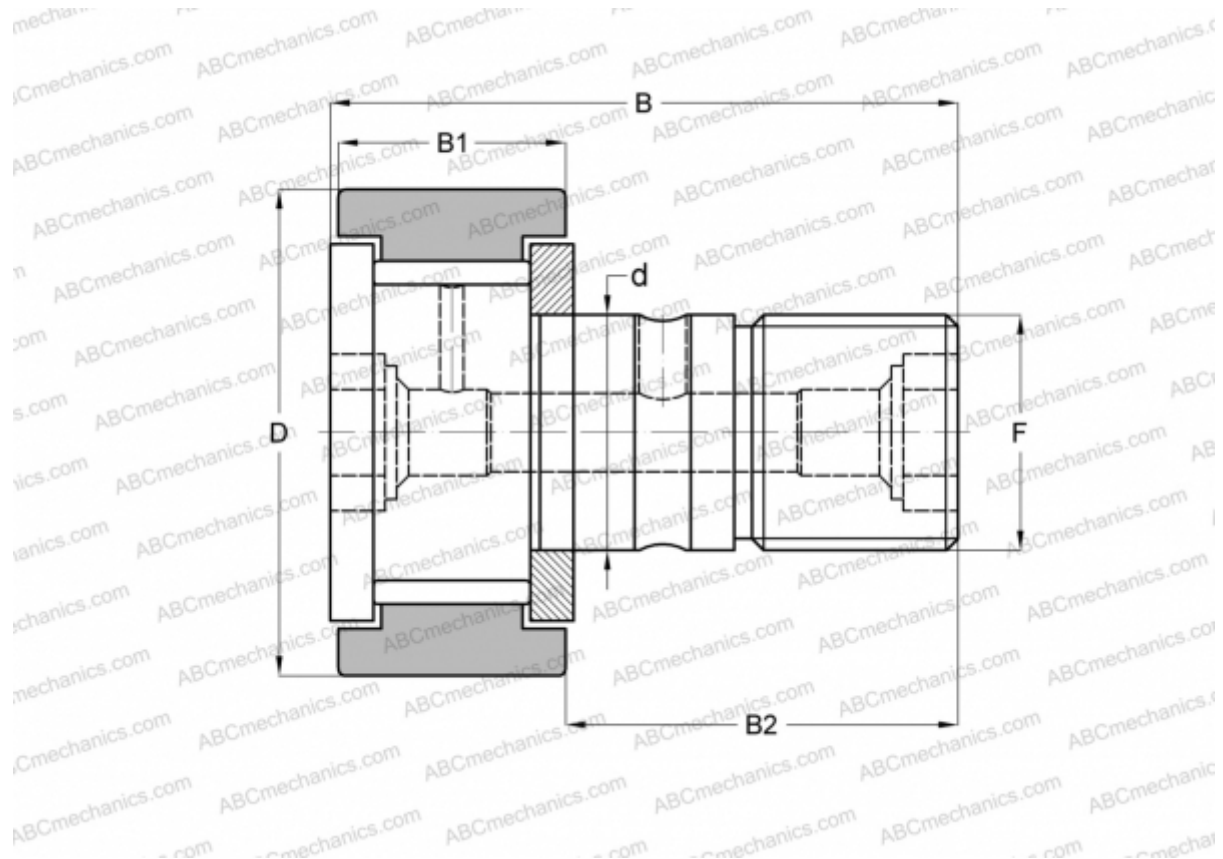

Technical specification

DIMENSIONS, MM

d	20,000
D	52,000
B	66,100
B1	24,000
B2	40,500
F	M20x1.5

WEIGHT, KG 0,465

MANUFACTURER [INA](#)

INTERCHANGE

ABC	CF 20 VB
IKO	CF 20 VB
SKF	KRV 52 XSK
McGill	MCF-52-BX