

KRV 62 X INA

Cam followers

TYPE: Roller bearings, Stud type track rollers, With axial guidance, full complement bearing, gap seal on both side, cylindrical outer ring, hex socket

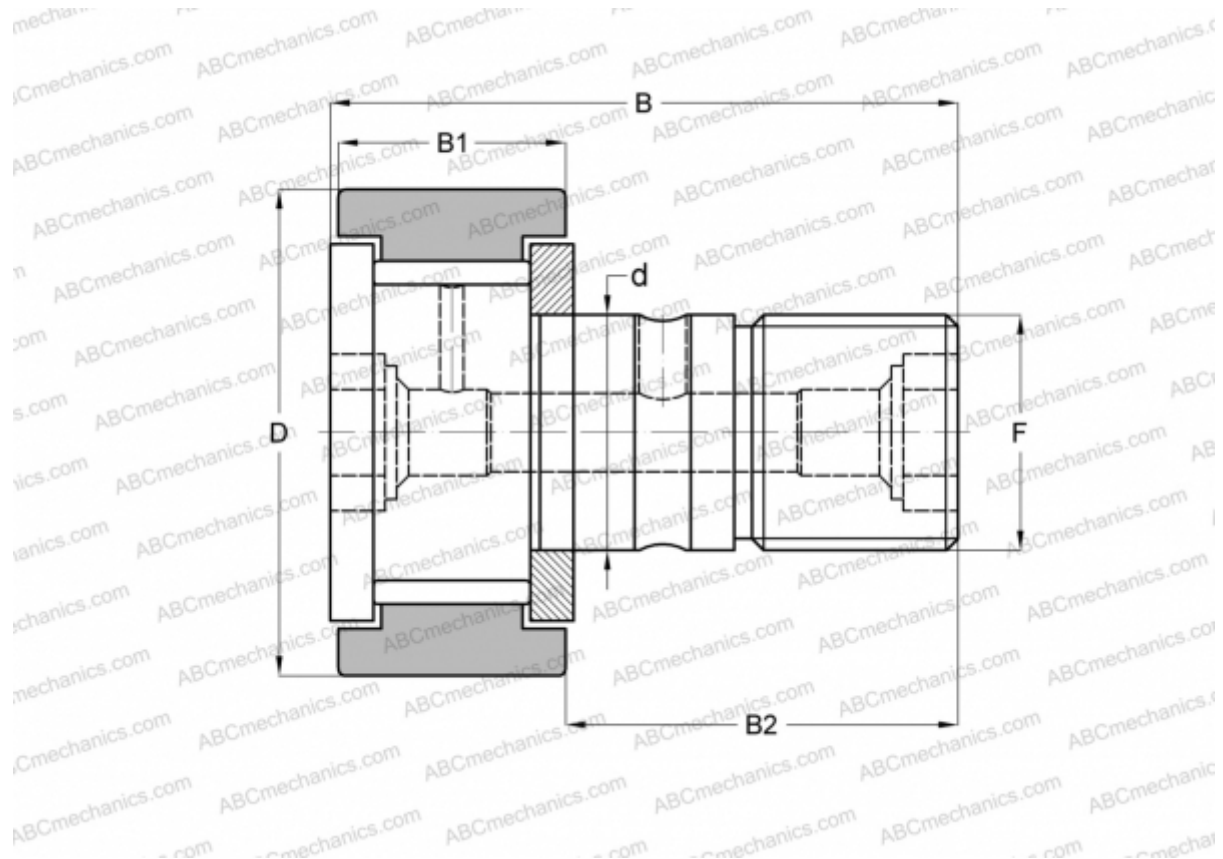

Technical specification

DIMENSIONS, MM

d	24,000
D	62,000
B	80,100
B1	29,000
B2	49,500
F	M24x1.5

WEIGHT, KG 0,820

MANUFACTURER [INA](#)

INTERCHANGE

ABC	CF 24 VB
IKO	CF 24 VB
SKF	KRV 62 X
McGill	MCF-62-BX