

KRV 35 PPXSK INA

Cam followers

TYPE: Roller bearings, Stud type track rollers, With axial guidance, full complement bearing, sealing rings on both sides, cylindrical outer ring

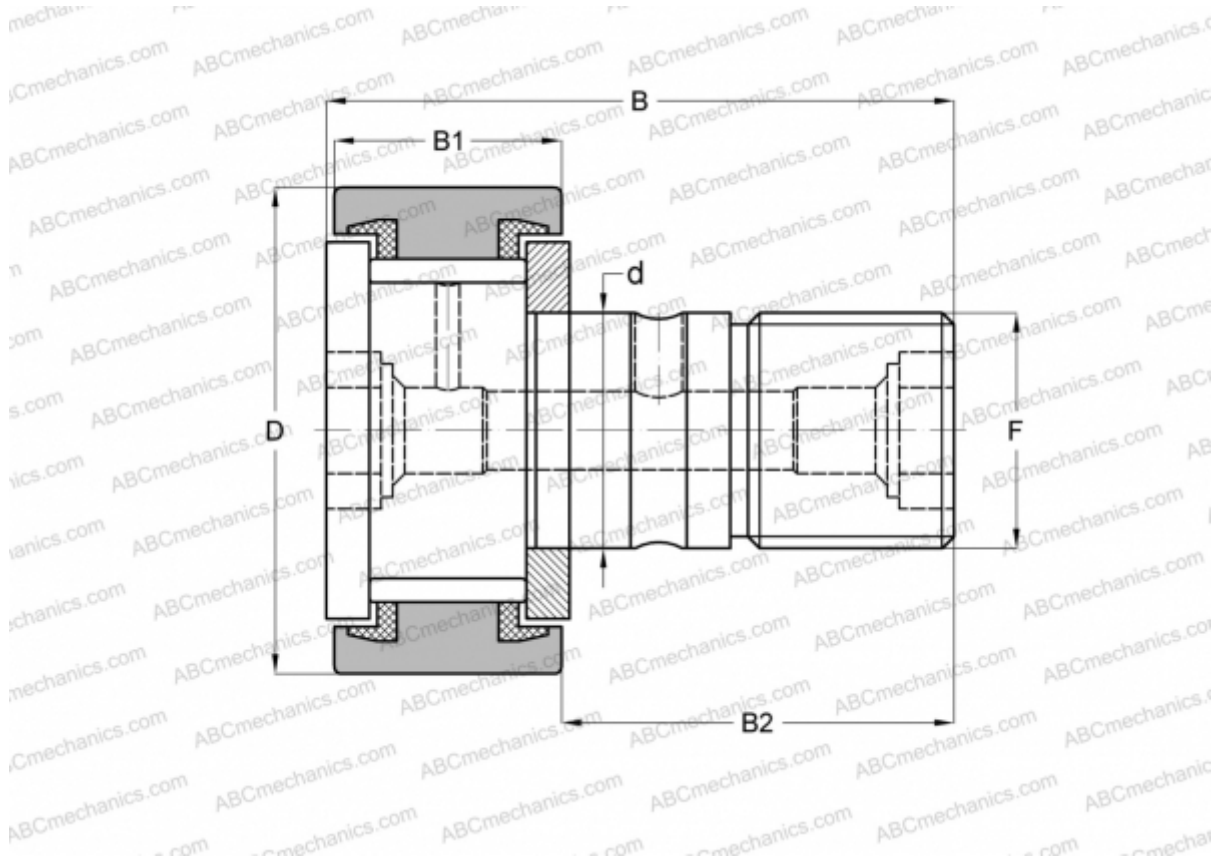

Technical specification

DIMENSIONS, MM

d	16,000
D	35,000
B	52,100
B1	18,000
B2	32,500
F	M16x1.5

WEIGHT, KG 0,173

MANUFACTURER [INA](#)

INTERCHANGE

ABC	CF 16 VBUU
IKO	CF 16 VBUU
SKF	KRV 35 PPXSK
McGill	MCF-35-SBX