

## CF 18 VBUU ABC

Cam followers

TYPE: Roller bearings, Stud type track rollers, With axial guidance, full complement bearing, sealing rings on both sides, cylindrical outer ring

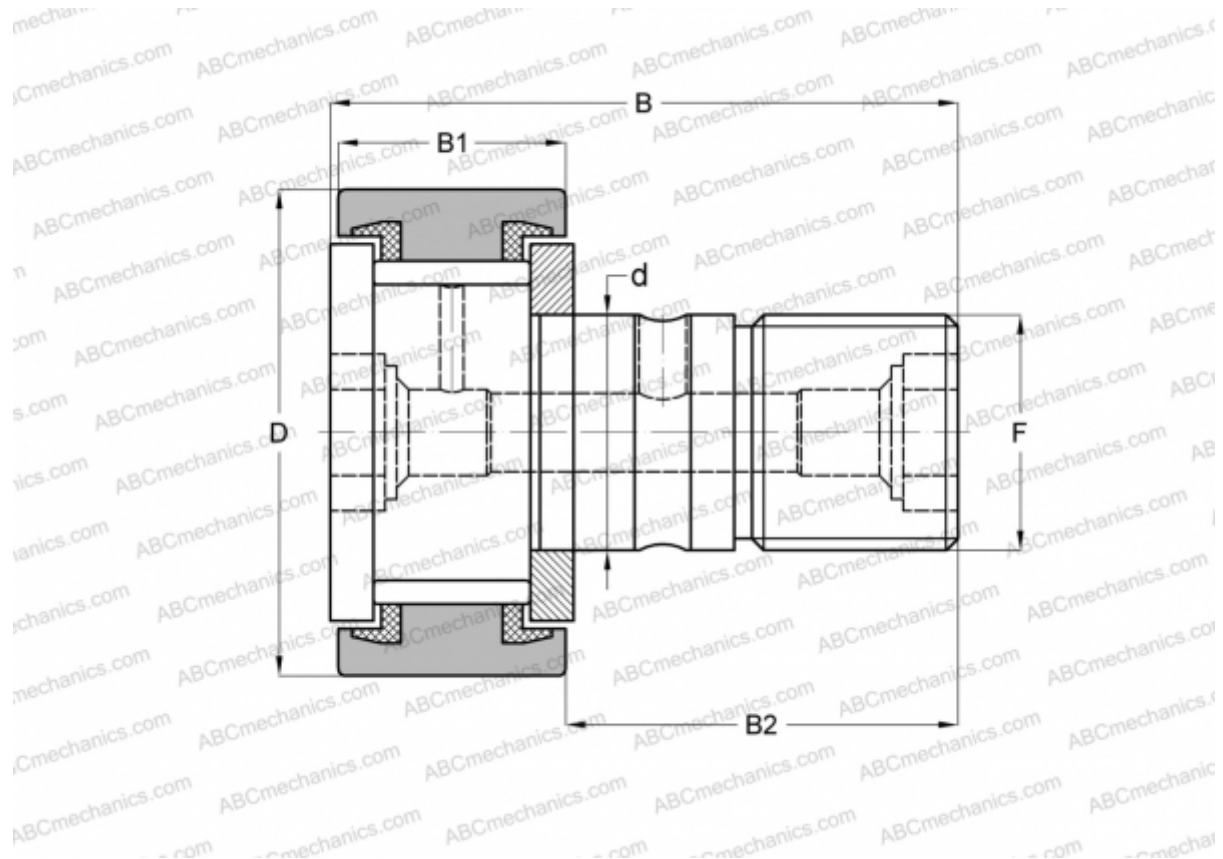

### Technical specification

#### DIMENSIONS, MM

d	18,000
D	40,000
B	58,100
B1	20,000
B2	36,500
F	M18x1.5

**WEIGHT, KG** 0,255

**MANUFACTURER** [ABC](#)

#### INTERCHANGE

IKO	<a href="#">CF 18 VBUU</a>
INA	<a href="#">KRV 40 PPXSK</a>
SKF	<a href="#">KRV 40 PPXSK</a>
McGill	<a href="#">MCF-40-SBX</a>