

CF 20 VBUU IKO

Cam followers

TYPE: Roller bearings, Stud type track rollers, With axial guidance, full complement bearing, sealing rings on both sides, cylindrical outer ring

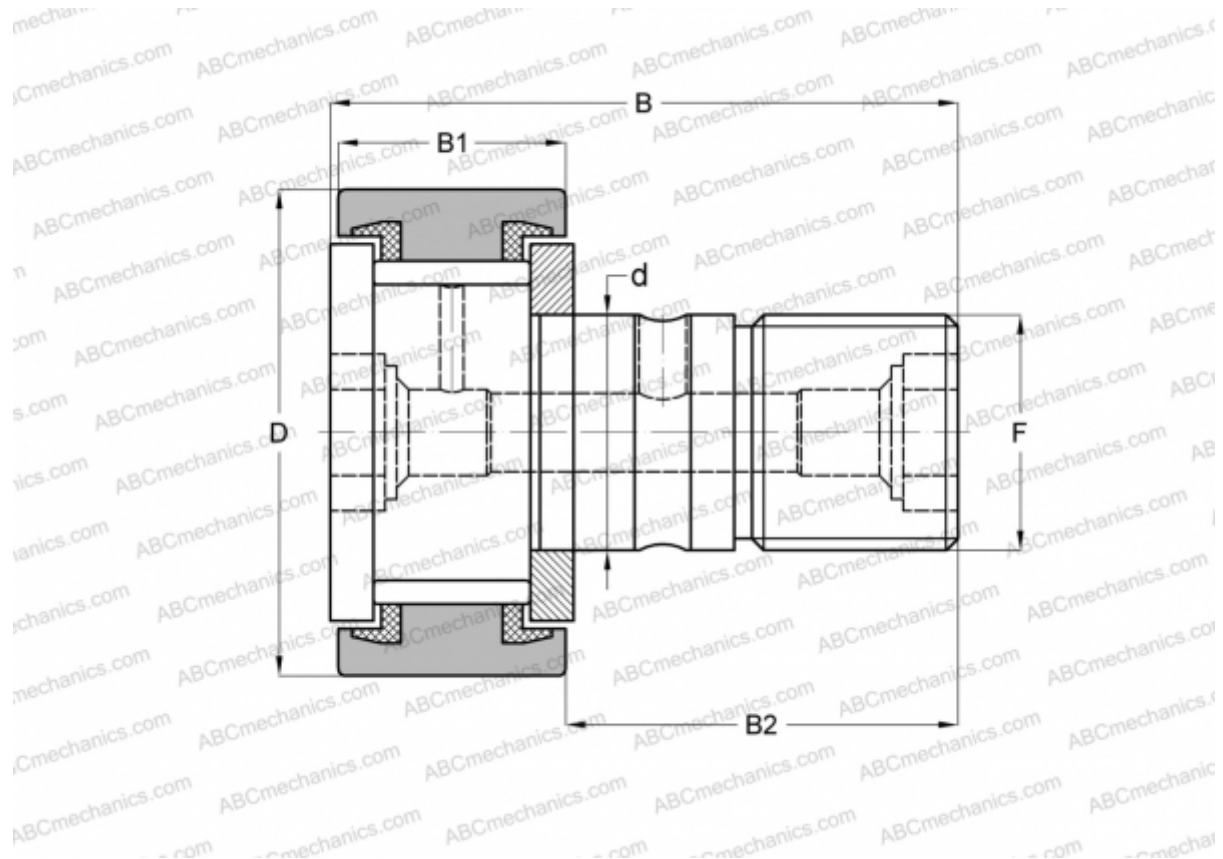

Technical specification

DIMENSIONS, MM

d	20,000
D	52,000
B	66,100
B1	24,000
B2	40,500
F	M20x1.5

WEIGHT, KG 0,465

MANUFACTURER [IKO](#)

INTERCHANGE

ABC	CF 20 VBUU
INA	KRV 52 PPXSK
SKF	KRV 52 PPXSK
McGill	MCF-52-SBX

CALCULATION DATA

Basic dynamic load rating, C	33,200 kN
Basic static load rating, Co	64,500 kN