

KRV 52 PPXSK INA

Cam followers

TYPE: Roller bearings, Stud type track rollers, With axial guidance, full complement bearing, sealing rings on both sides, cylindrical outer ring

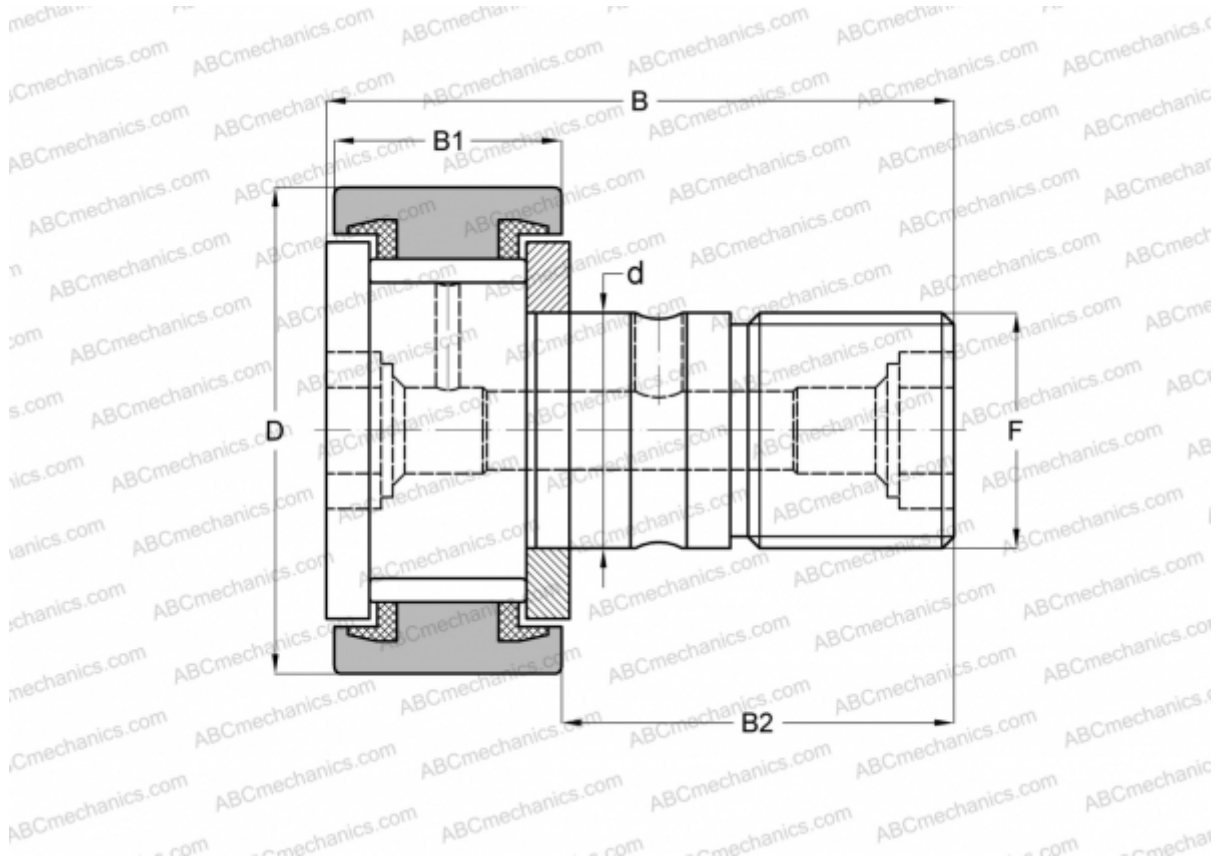

Technical specification

DIMENSIONS, MM

d	20,000
D	52,000
B	66,100
B1	24,000
B2	40,500
F	M20x1.5

WEIGHT, KG 0,465

MANUFACTURER [INA](#)

INTERCHANGE

ABC	CF 20 VBUU
IKO	CF 20 VBUU
SKF	KRV 52 PPXSK
McGill	MCF-52-SBX