

## MCF-47-SBX McGill

Cam followers

TYPE: Roller bearings, Stud type track rollers, With axial guidance, full complement bearing, sealing rings on both sides, cylindrical outer ring

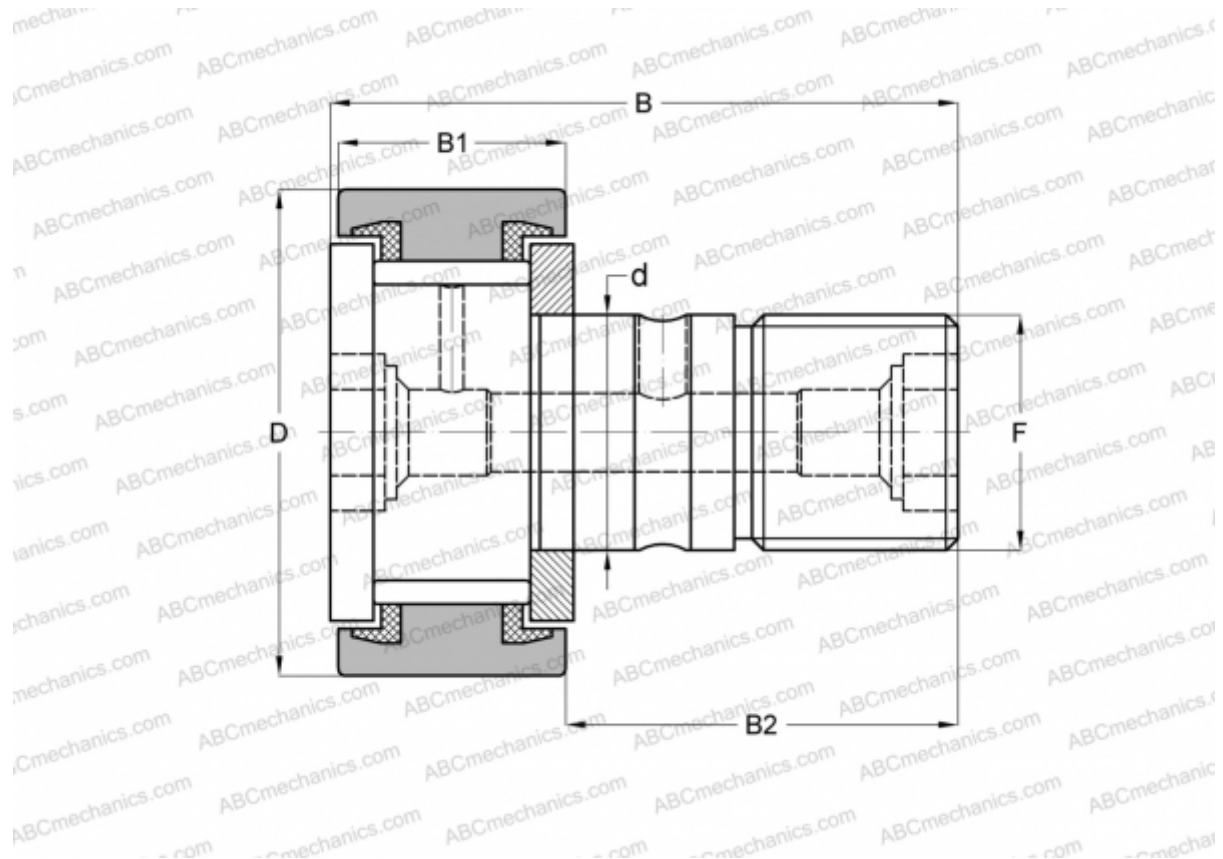

### Technical specification

#### DIMENSIONS, MM

d	20,000
D	47,000
B	66,100
B1	24,000
B2	40,500
F	M20x1.5

**WEIGHT, KG** 0,390

**MANUFACTURER** [McGill](#)

#### INTERCHANGE

ABC	<a href="#">CF 20-1 VBUU</a>
IKO	<a href="#">CF 20-1 VBUU</a>
INA	<a href="#">KRV 47 PPXSK</a>
SKF	<a href="#">KRV 47 PPXSK</a>