

## CF 5 FBR IKO

Cam followers

TYPE: Roller bearings, Stud type track rollers, With axial guidance, gap seals on both side, stainless steel, hex hole

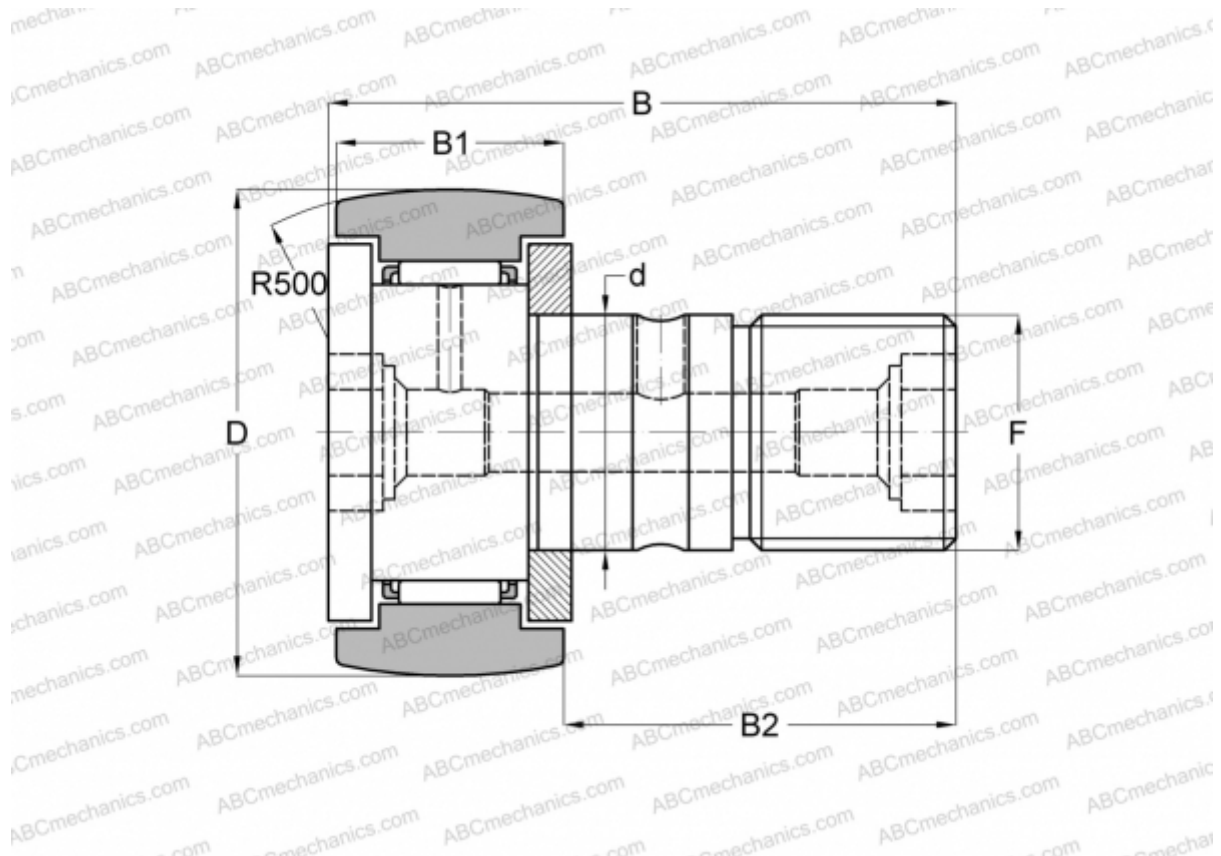

### Technical specification

#### DIMENSIONS, MM

d	5,000
D	13,000
B	23,000
B1	9,000
B2	13,000
F	M5x0.8

**WEIGHT, KG** 0,010

**MANUFACTURER** [IKO](#)

#### CALCULATION DATA

Basic dynamic load rating, C	1,930 kN
Basic static load rating, Co	1,730 kN