

CF 3 FBUUR IKO

Cam followers

TYPE: Roller bearings, Stud type track rollers, With axial guidance, sealing rings on both sides, stainless steel, hex hole

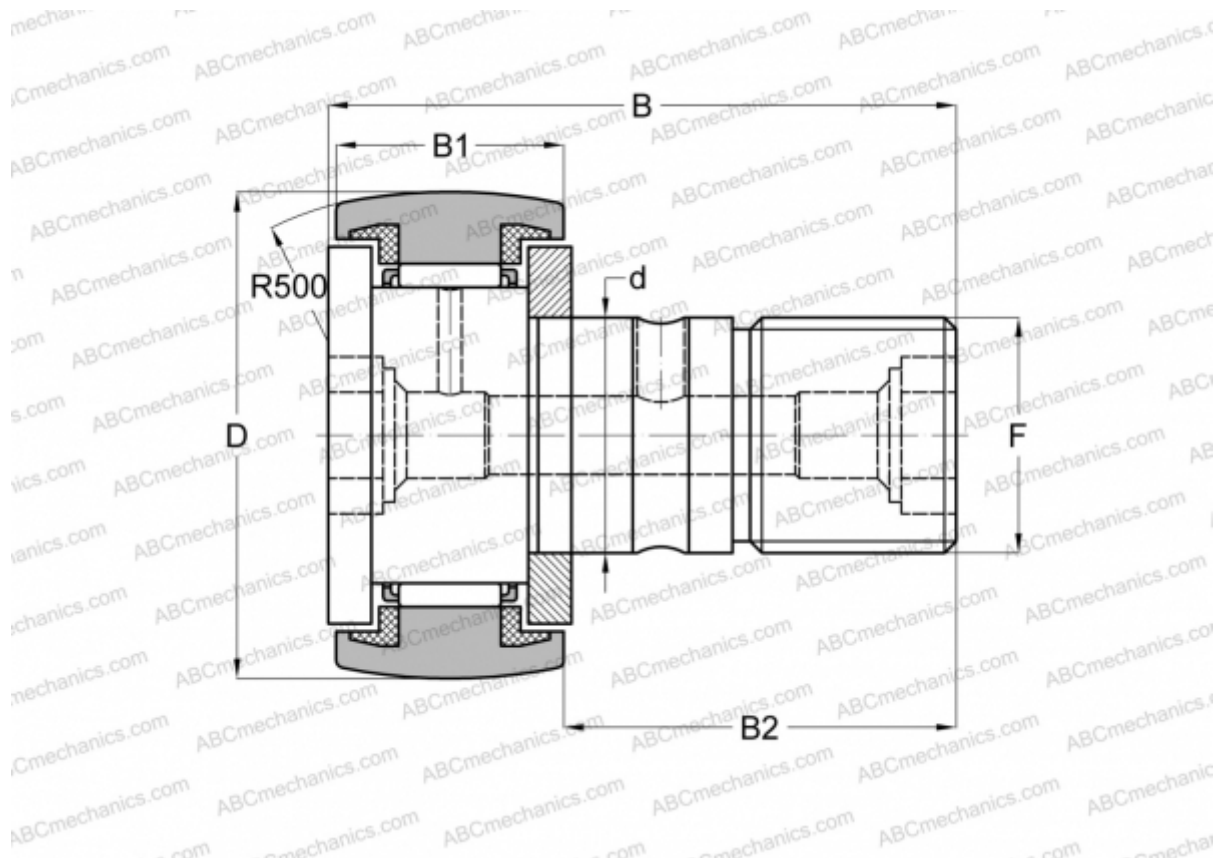

Technical specification

DIMENSIONS, MM

d	3,000
D	10,000
B	17,000
B1	7,000
B2	9,000
F	M3x0.5

WEIGHT, KG 0,004

MANUFACTURER [IKO](#)

CALCULATION DATA

Basic dynamic load rating, C	1,200 kN
Basic static load rating, Co	0,813 kN