

CF 4 FBUUR IKO

Cam followers

TYPE: Roller bearings, Stud type track rollers, With axial guidance, sealing rings on both sides, stainless steel, hex hole

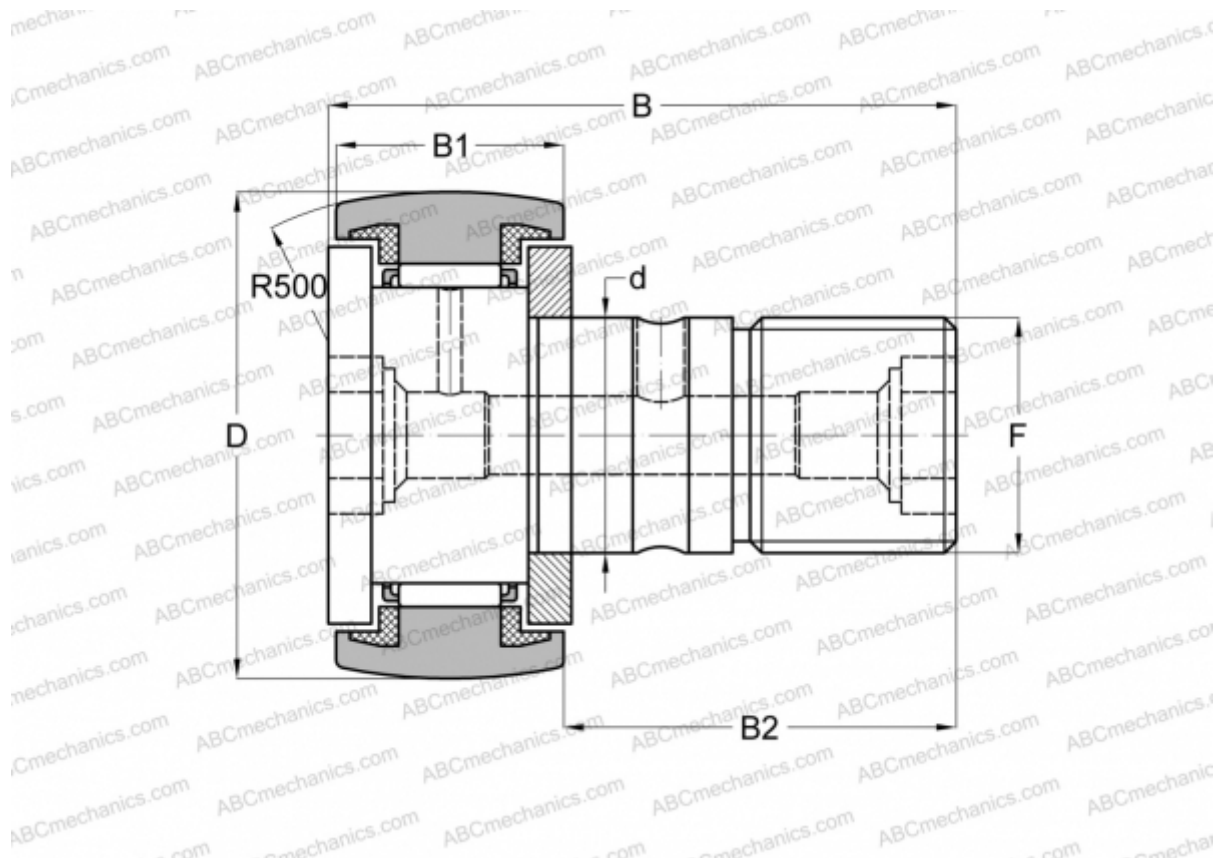

Technical specification

DIMENSIONS, MM

d	4,000
D	12,000
B	20,000
B1	8,000
B2	11,000
F	M4x0.7

WEIGHT, KG 0,007

MANUFACTURER [IKO](#)

CALCULATION DATA

Basic dynamic load rating, C	1,650 kN
Basic static load rating, Co	1,270 kN