

## CF 3 FWBR IKO

Cam followers

TYPE: Roller bearings, Stud type track rollers, With axial guidance, gap seals on both side, stainless thrust disk type, hex hole

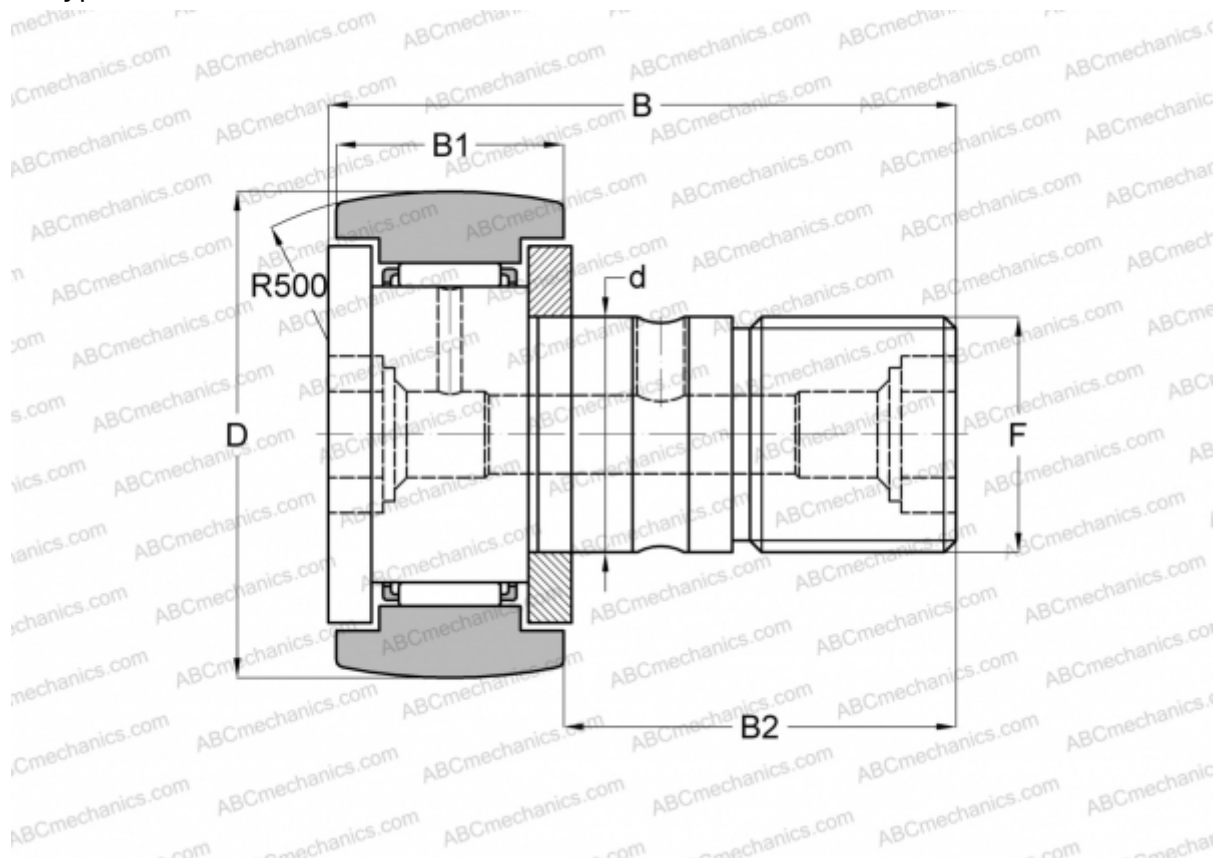

### Technical specification

#### DIMENSIONS, MM

d	3,000
D	10,000
B	17,000
B1	7,000
B2	9,000
F	M3x0.5

**WEIGHT, KG** 0,004

**MANUFACTURER** [IKO](#)

#### CALCULATION DATA

Basic dynamic load rating, C	1,200 kN
Basic static load rating, Co	0,813 kN