

CF 5 FWBUUR IKO

Cam followers

TYPE: Roller bearings, Stud type track rollers, With axial guidance, sealing rings on both sides, stainless thrust disk type, hex hole

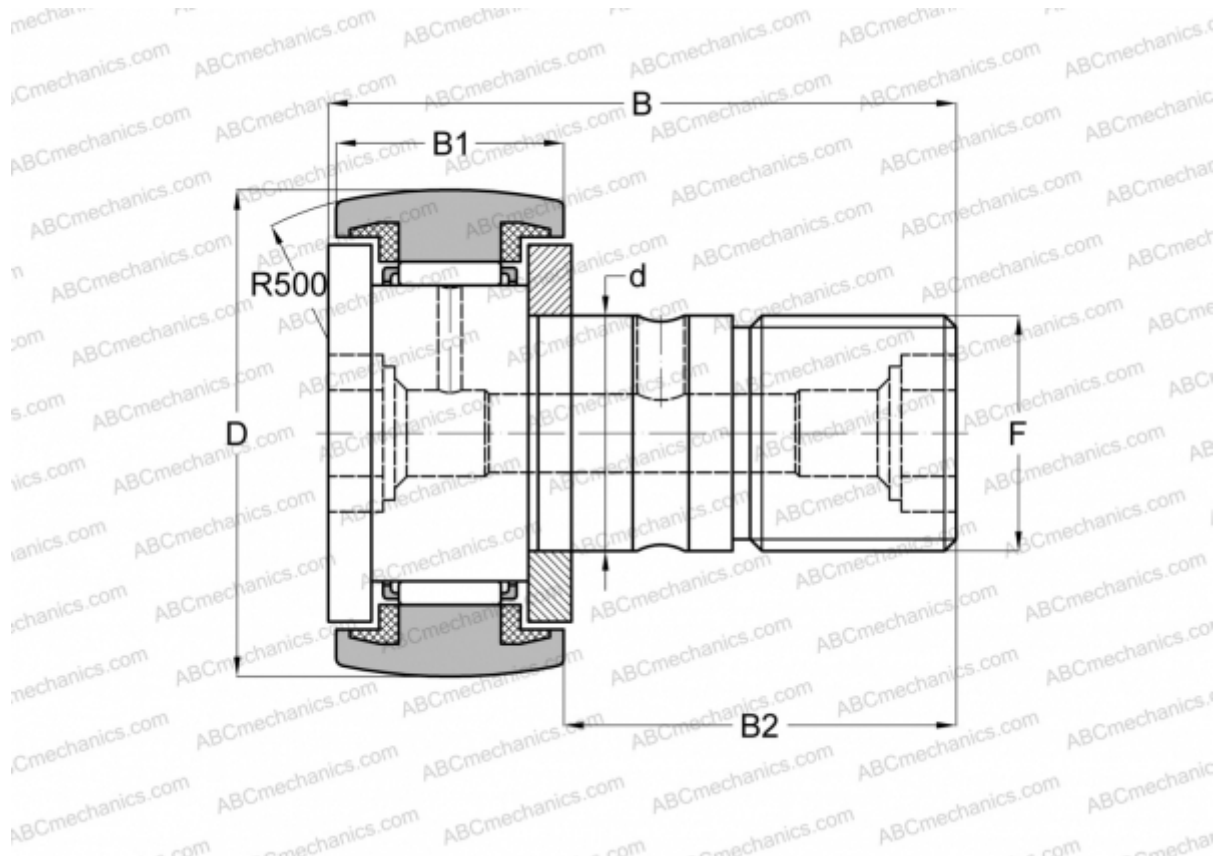

Technical specification

DIMENSIONS, MM

d	5,000
D	13,000
B	23,000
B1	9,000
B2	13,000
F	M5x0.8

WEIGHT, KG 0,010

MANUFACTURER [IKO](#)

CALCULATION DATA

Basic dynamic load rating, C	1,930 kN
Basic static load rating, Co	1,730 kN