

KRE 35 INA

Cam followers

TYPE: Roller bearings, Stud type track rollers, With axial guidance, with eccentric collar

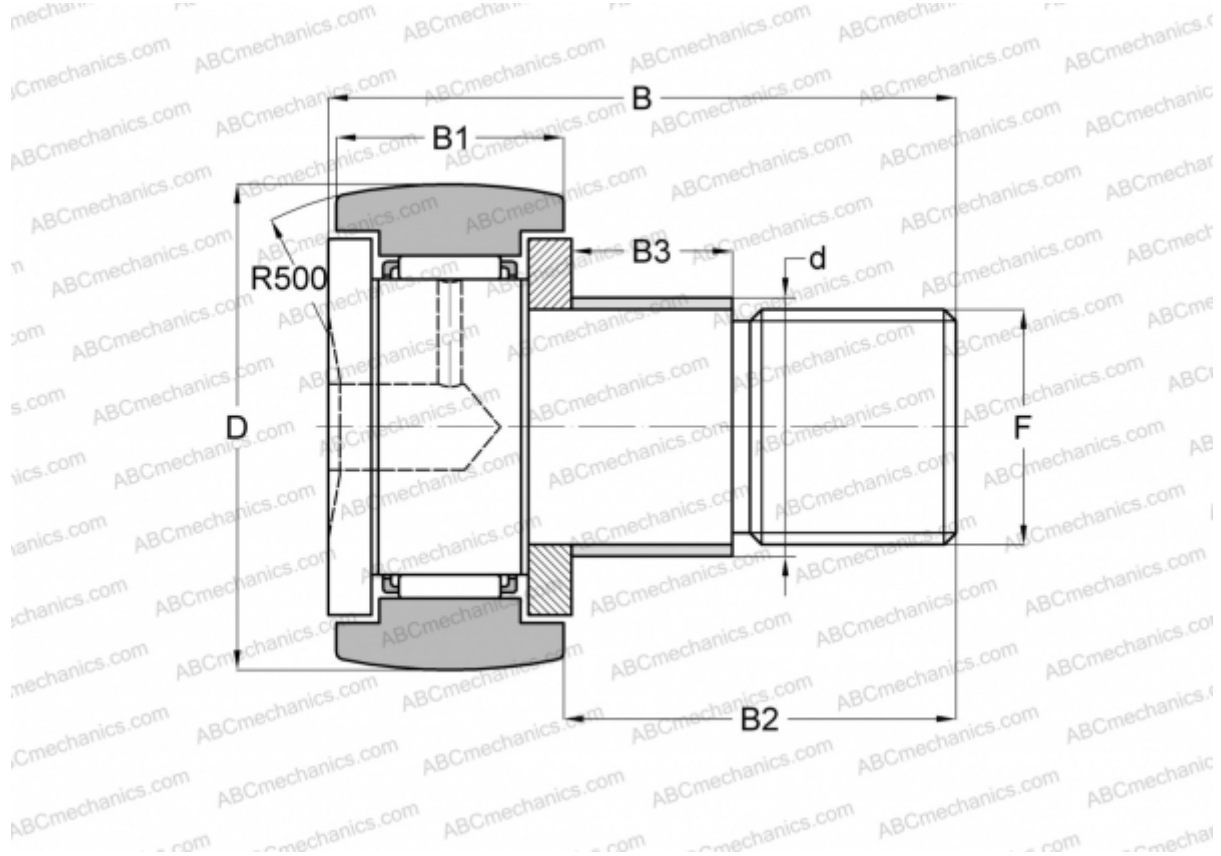

Technical specification

DIMENSIONS, MM

d	20,000
D	35,000
B	52,000
B1	18,000
B2	32,500
B3	14,000
F	M16x1.5

WEIGHT, KG 0,177

MANUFACTURER [INA](#)

INTERCHANGE

ABC [KRE 35](#)