

KRE 32 X ABC

Cam followers

TYPE: Roller bearings, Stud type track rollers, With axial guidance, with eccentric collar, cylindrical outer ring

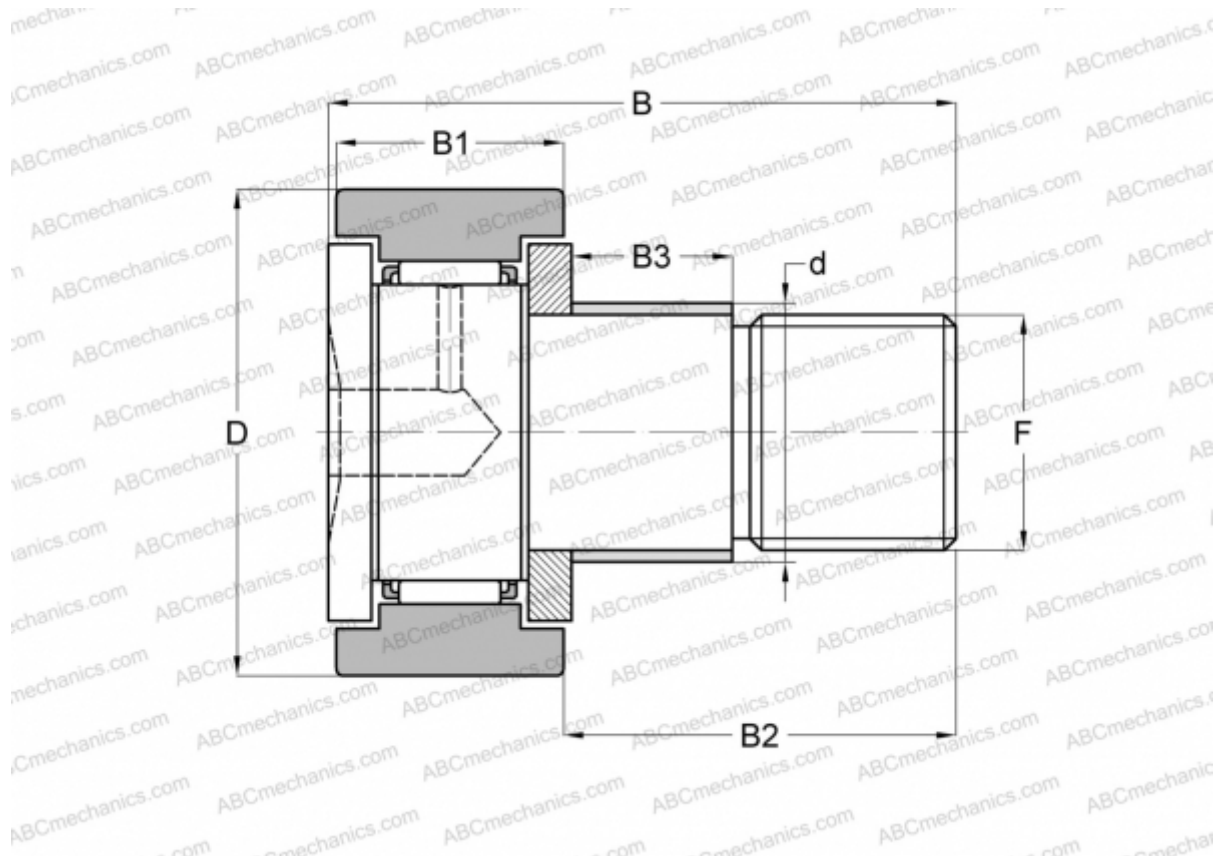

Technical specification

DIMENSIONS, MM

d	15,000
D	32,000
B	40,000
B1	14,000
B2	25,000
B3	11,000
F	M12x1.5

WEIGHT, KG 0,104

MANUFACTURER [ABC](#)

INTERCHANGE

INA [KRE 32 X](#)