

CFE 12 IKO

Cam followers

TYPE: Roller bearings, Stud type track rollers, With axial guidance, with eccentric collar, cylindrical outer ring

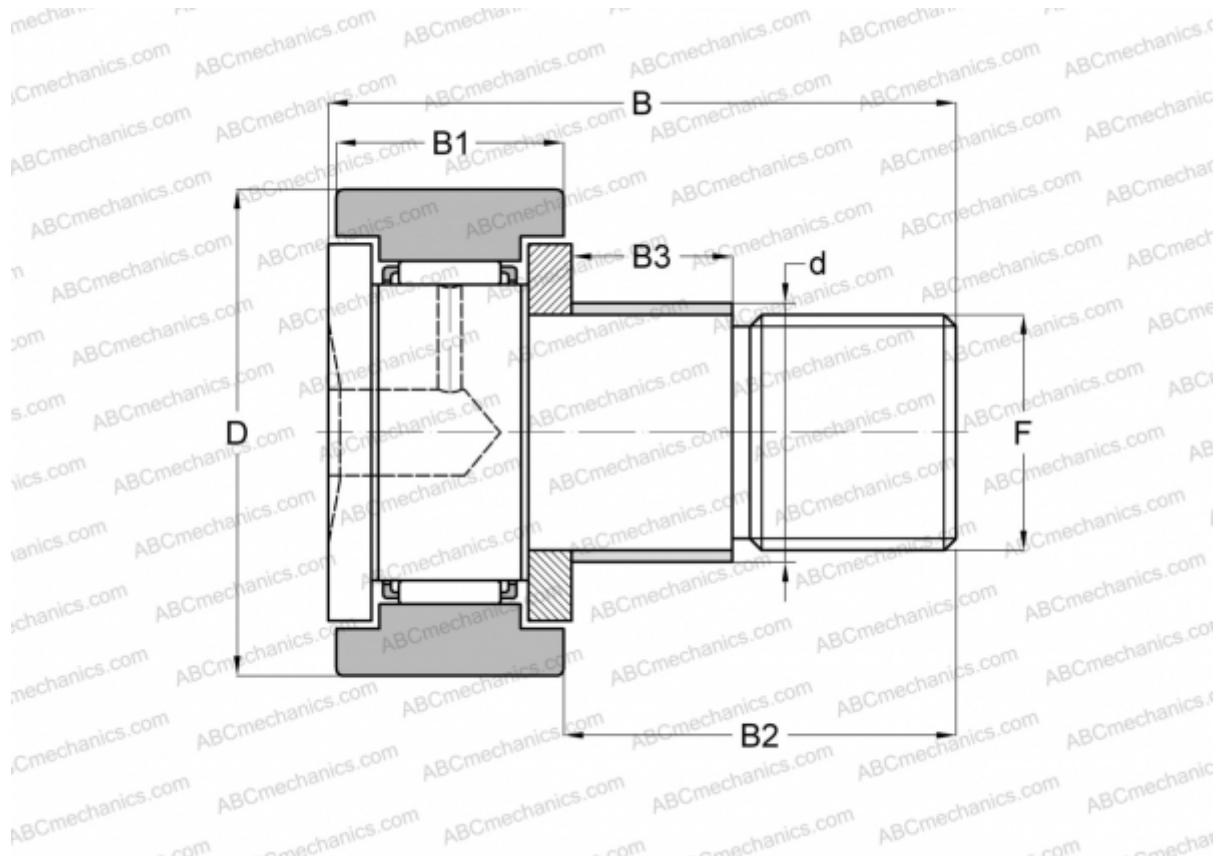

Technical specification

DIMENSIONS, MM

d	16,000
D	30,000
B	40,200
B1	14,000
B2	25,000
F	M12x1.5

MANUFACTURER [IKO](#)

INTERCHANGE

ABC [CFE 12](#)

CALCULATION DATA

Basic dynamic load rating, C	7,910 kN
Basic static load rating, Co	9,790 kN