

KRE 40 X ABC

Cam followers

TYPE: Roller bearings, Stud type track rollers, With axial guidance, with eccentric collar, cylindrical outer ring

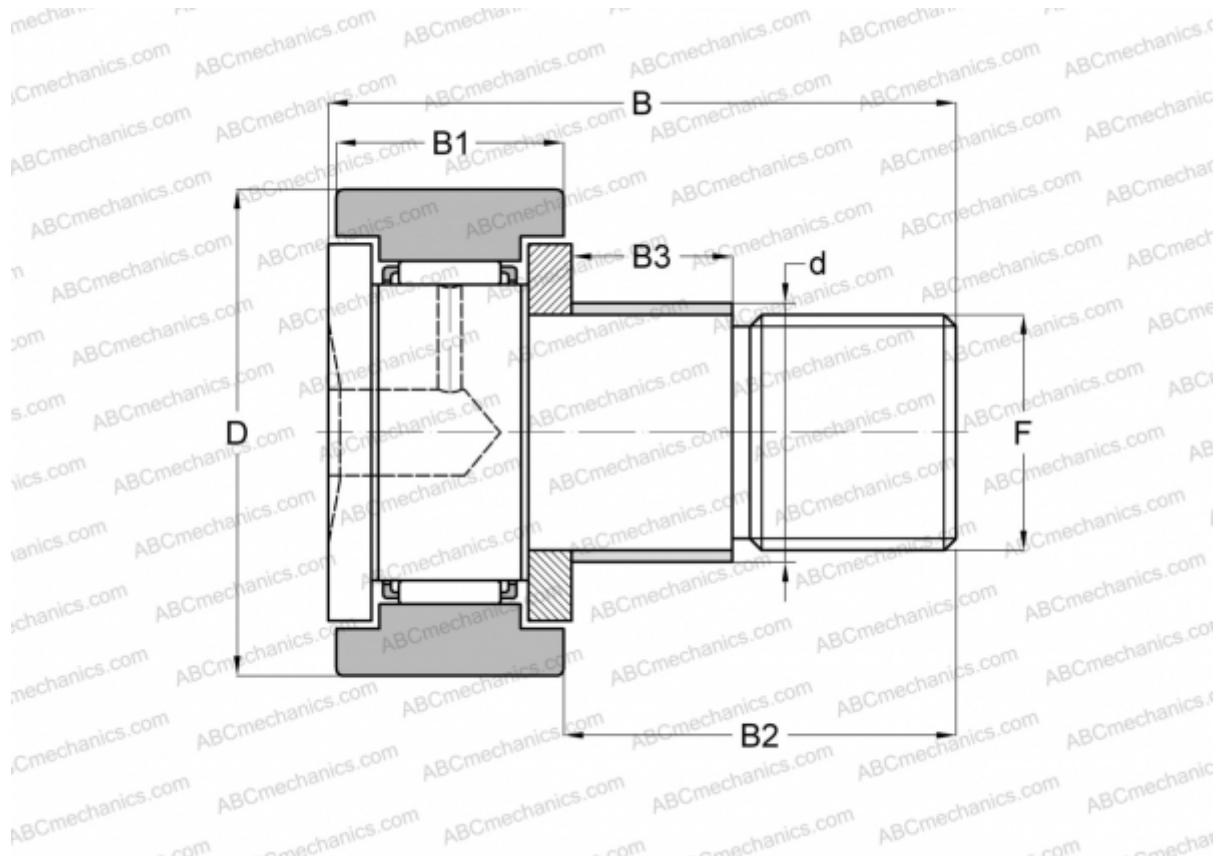

Technical specification

DIMENSIONS, MM

d	22,000
D	40,000
B	58,000
B1	20,000
B2	36,500
B3	16,000
F	M18x1.5

MANUFACTURER [ABC](#)

INTERCHANGE

INA [KRE 40 X](#)