

CFE 16 ABC

Cam followers

TYPE: Roller bearings, Stud type track rollers, With axial guidance, with eccentric collar, cylindrical outer ring

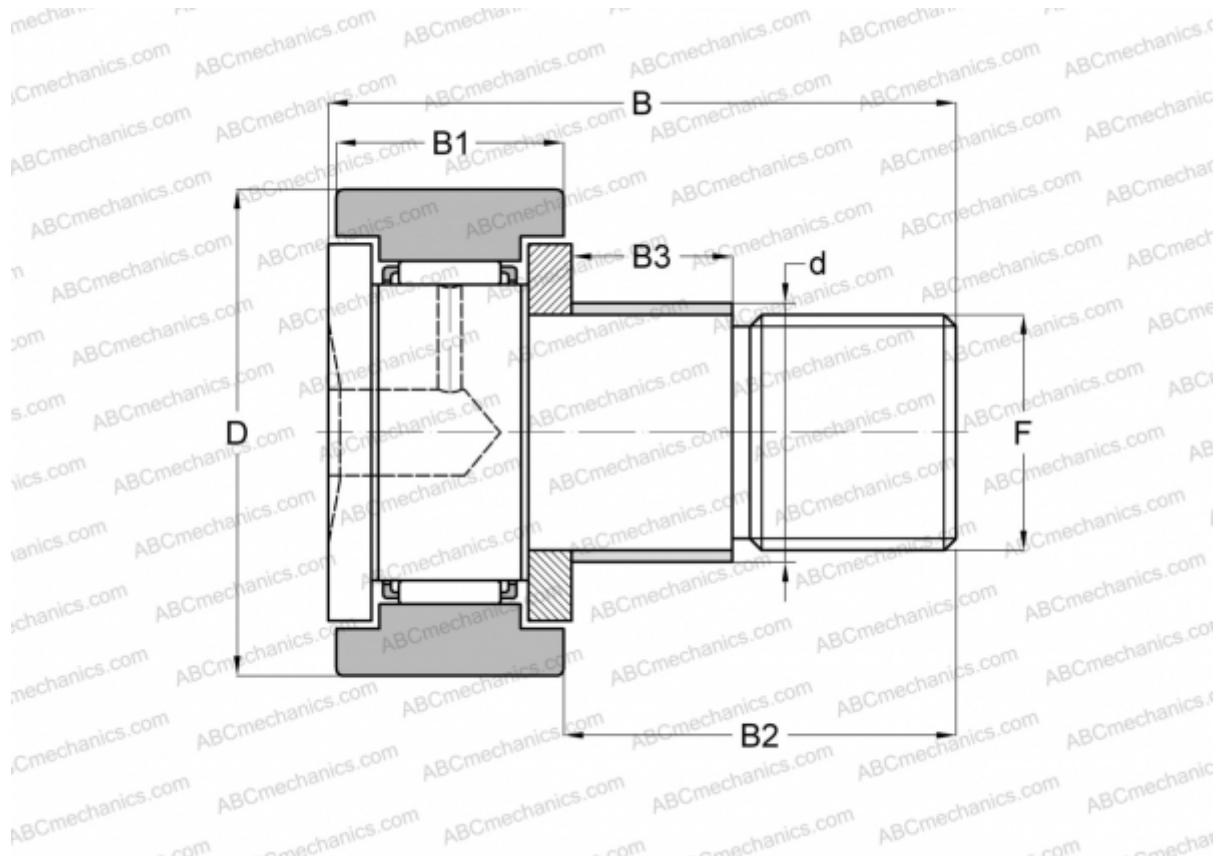

Technical specification

DIMENSIONS, MM

d	22,000
D	35,000
B	52,100
B1	18,000
B2	32,500
F	M16x1.5

MANUFACTURER [ABC](#)

INTERCHANGE

IKO [CFE 16](#)