

KRE 52 X ABC

Cam followers

TYPE: Roller bearings, Stud type track rollers, With axial guidance, with eccentric collar, cylindrical outer ring

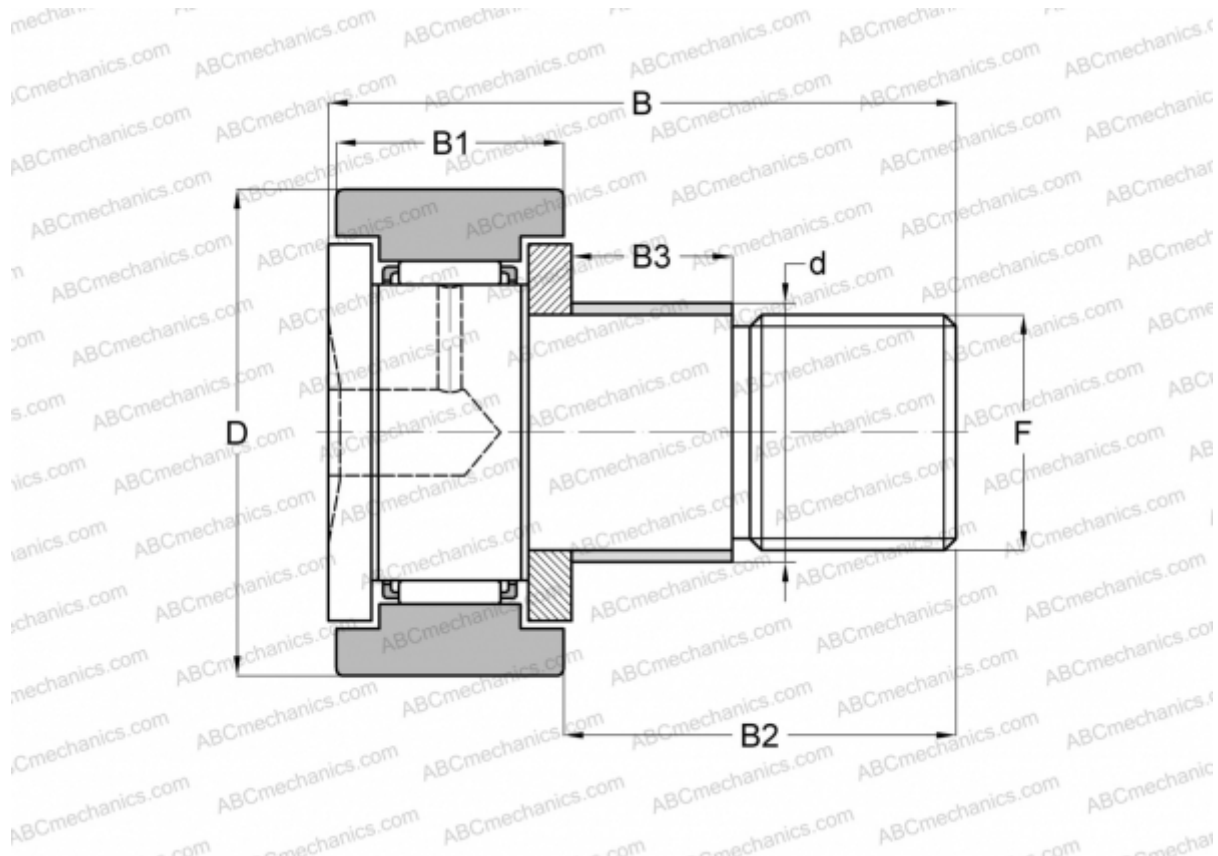

Technical specification

DIMENSIONS, MM

d	24,000
D	52,000
B	66,000
B1	24,000
B2	40,500
B3	18,000
F	M20x1.5

WEIGHT, KG 0,473

MANUFACTURER [ABC](#)

INTERCHANGE

INA [KRE 52 X](#)