

KRE 72 X INA

Cam followers

TYPE: Roller bearings, Stud type track rollers, With axial guidance, with eccentric collar, cylindrical outer ring

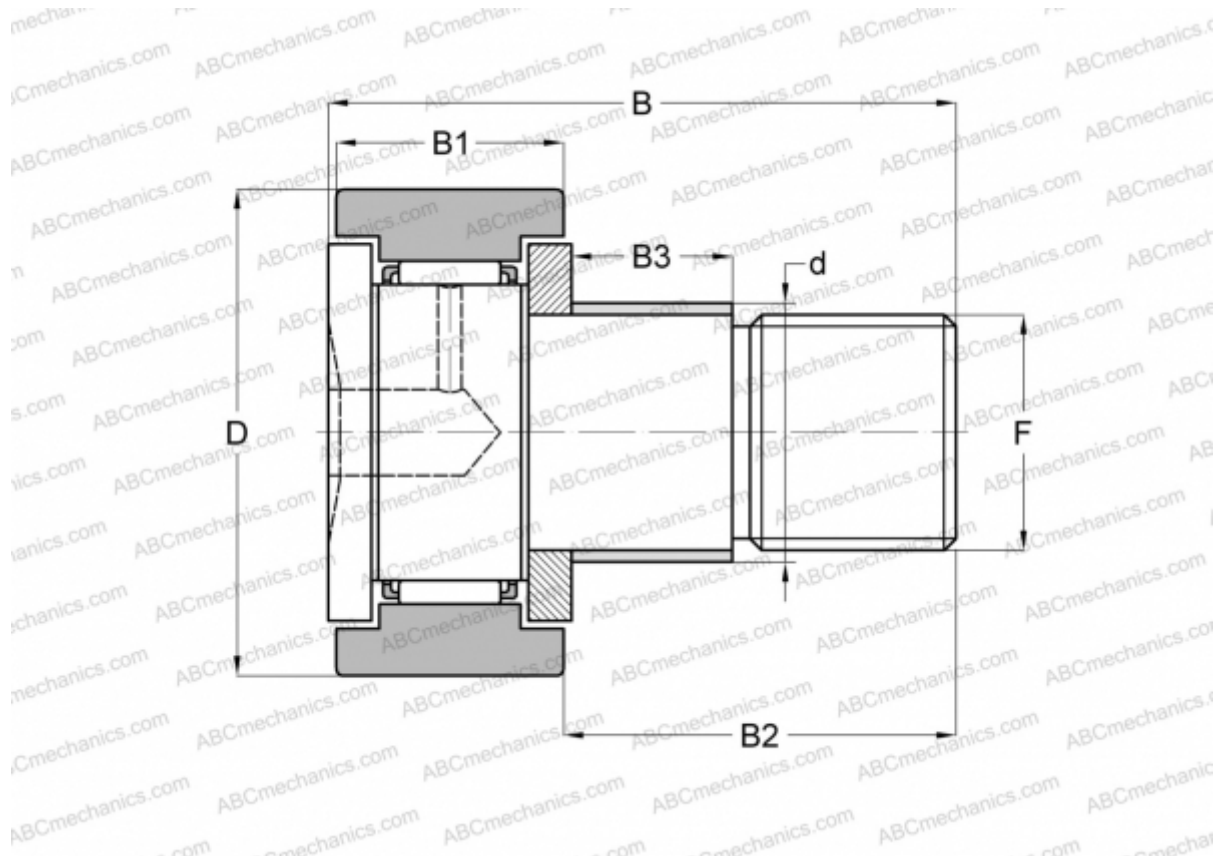

Technical specification

DIMENSIONS, MM

d	28,000
D	72,000
B	80,000
B1	29,000
B2	49,500
B3	22,000
F	M24x1.5

WEIGHT, KG 1,038

MANUFACTURER [INA](#)

INTERCHANGE

ABC [KRE 72 X](#)