

KRE 30 PP ABC

Cam followers

TYPE: Roller bearings, Stud type track rollers, With axial guidance, with eccentric collar, sealing rings on both sides

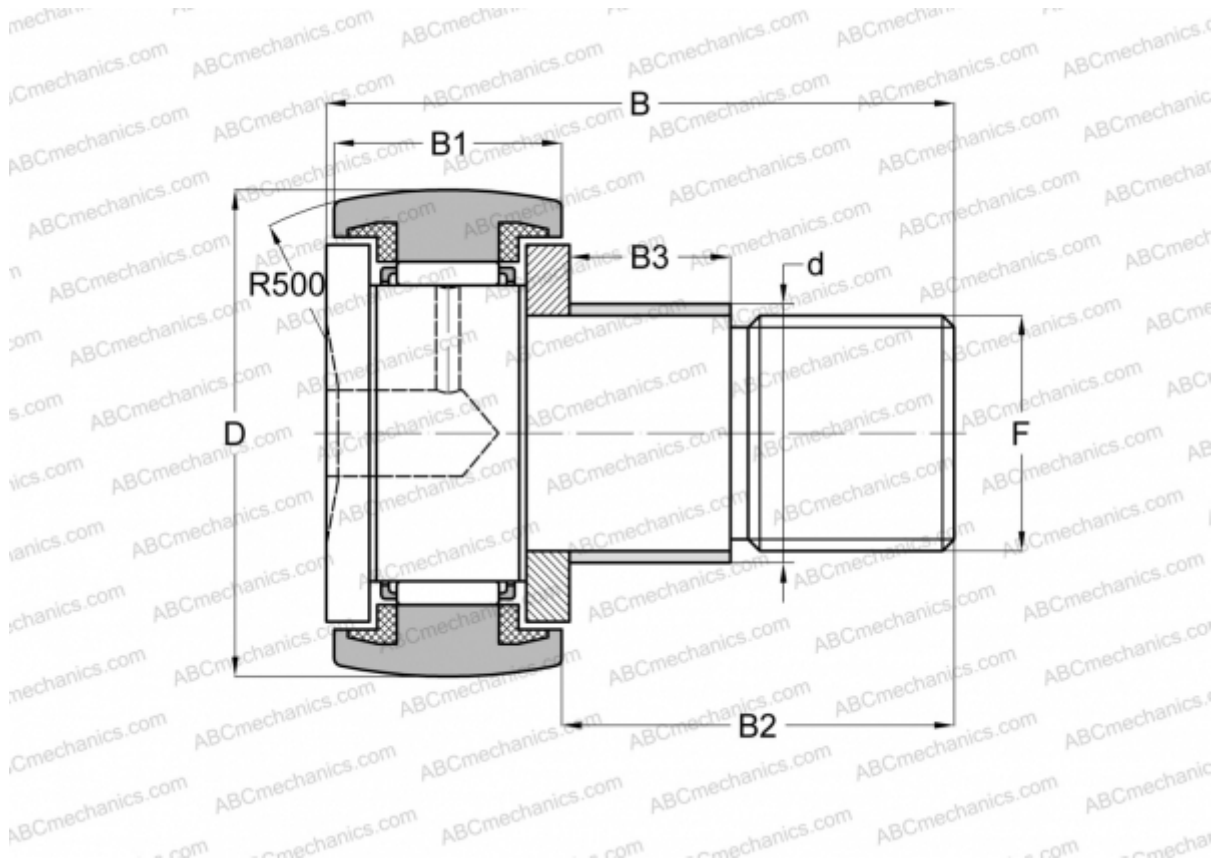

Technical specification

DIMENSIONS, MM

d	15,000
D	30,000
B	40,000
B1	14,000
B2	25,000
B3	11,000
F	M12x1,5

WEIGHT, KG 0,095

MANUFACTURER [ABC](#)

INTERCHANGE

SKF	KRE 30 PPA
INA	KRE 30 PPA