

KRE 32 PPA INA

Cam followers

TYPE: Roller bearings, Stud type track rollers, With axial guidance, with eccentric collar, sealing rings on both sides

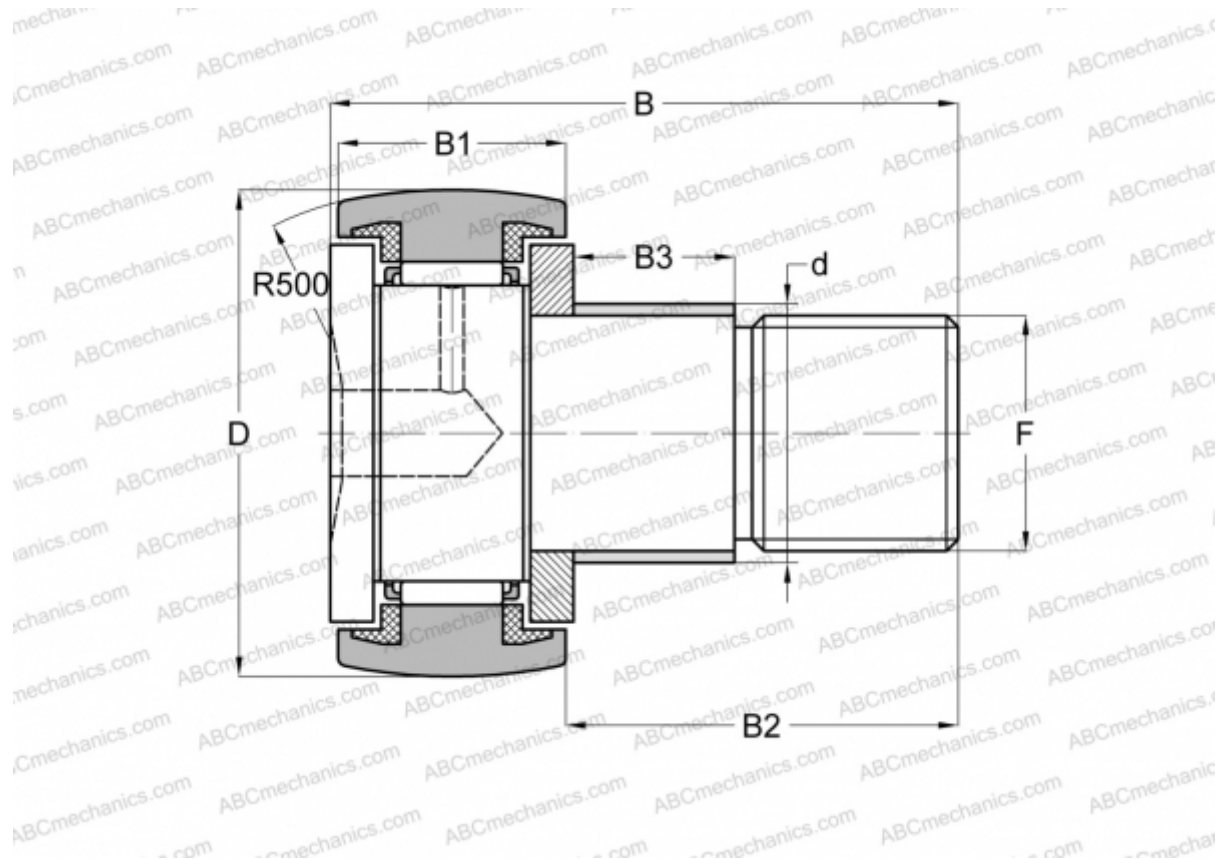

Technical specification

DIMENSIONS, MM

d	15,000
D	32,000
B	40,000
B1	14,000
B2	25,000
B3	11,000
F	M12x1,5

WEIGHT, KG 0,104

MANUFACTURER [INA](#)

INTERCHANGE

ABC	KRE 32 PP
SKF	KRE 32 PPA