

KRE 47 PP ABC

Cam followers

TYPE: Roller bearings, Stud type track rollers, With axial guidance, with eccentric collar, sealing rings on both sides

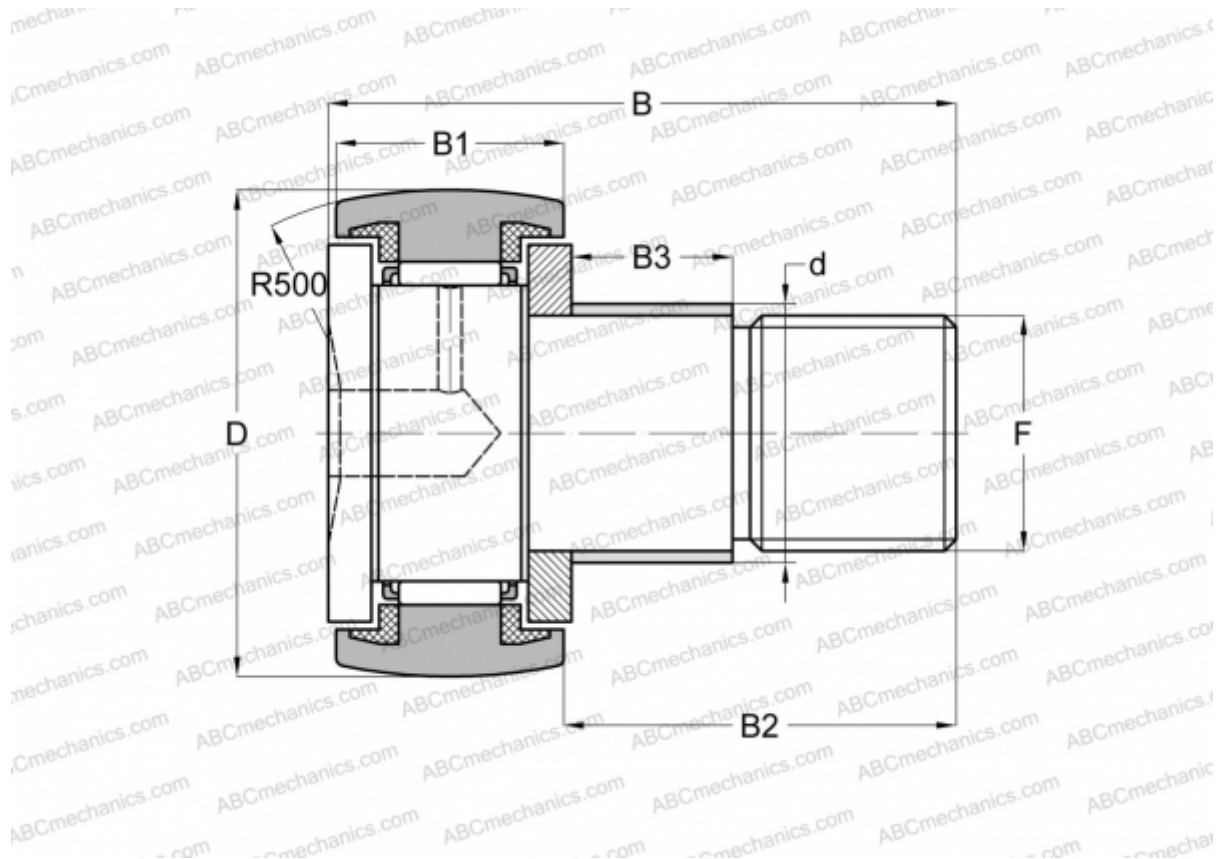

Technical specification

DIMENSIONS, MM

d	24,000
D	47,000
B	66,000
B1	24,000
B2	40,500
B3	18,000
F	M20x1,5

WEIGHT, KG 0,400

MANUFACTURER [ABC](#)

INTERCHANGE

SKF	KRE 47 PPA
INA	KRE 47 PPA