

KRE 80 PP ABC

Cam followers

TYPE: Roller bearings, Stud type track rollers, With axial guidance, with eccentric collar, sealing rings on both sides

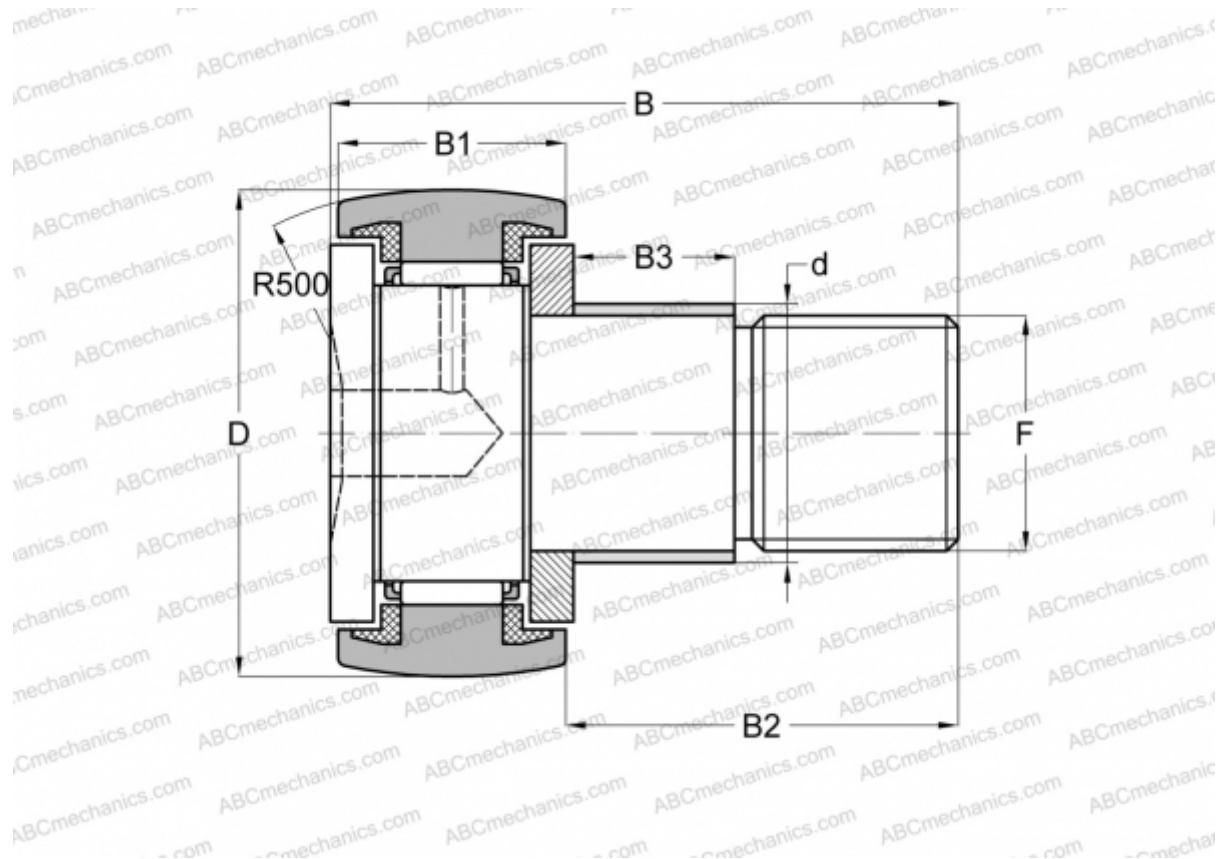

Technical specification

DIMENSIONS, MM

d	35,000
D	80,000
B	100,000
B1	35,000
B2	63,000
B3	29,000
F	M30x1,5

WEIGHT, KG 1,665

MANUFACTURER [ABC](#)

INTERCHANGE

SKF	KRE 80 PPA
INA	KRE 80 PPA