

## CFE 12-1 R IKO

Cam followers

TYPE: Roller bearings, Stud type track rollers, With axial guidance, with eccentric collar, sealing rings on both sides

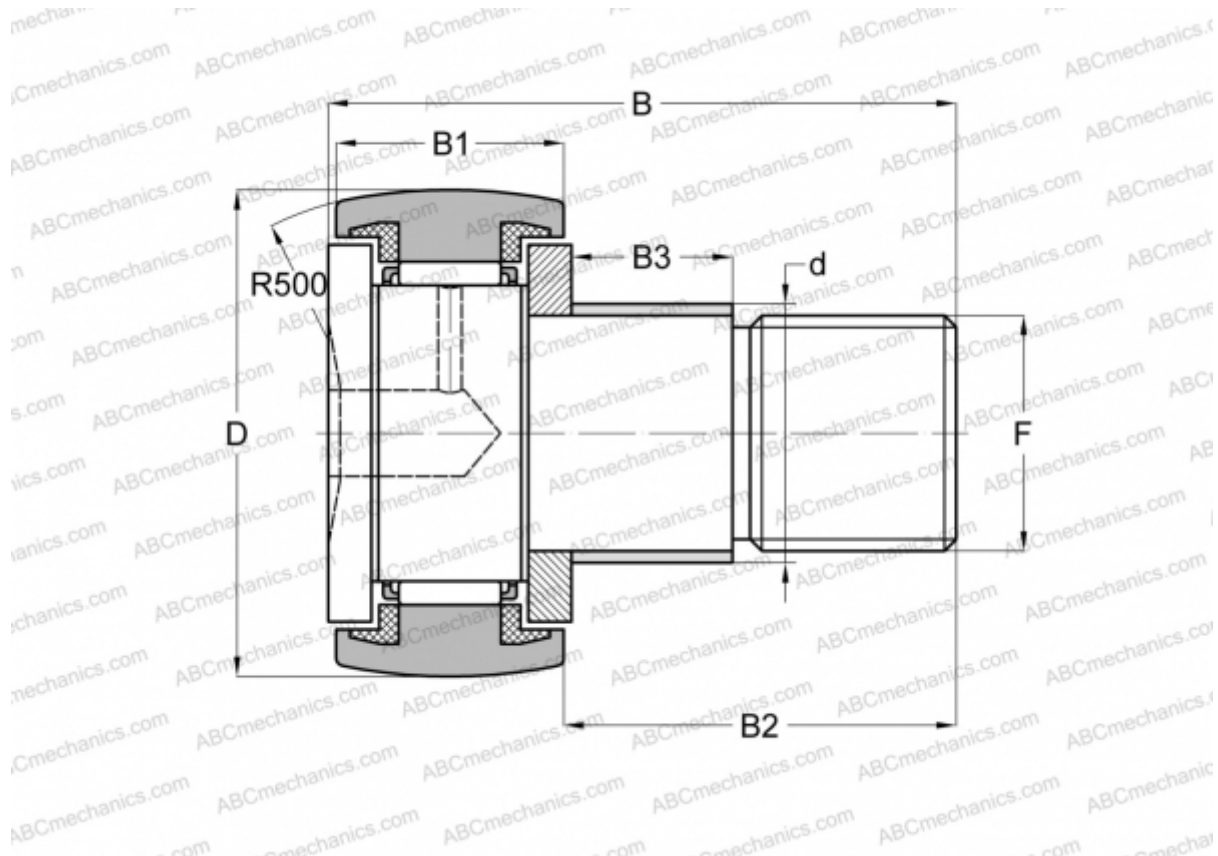

### Technical specification

#### DIMENSIONS, MM

d	16,000
D	32,000
B	40,200
B1	14,000
B2	25,000
F	M12x1.5

**WEIGHT, KG** 0,115

**MANUFACTURER** [IKO](http://www.iko.com)

#### CALCULATION DATA

Basic dynamic load rating, C	7,910 kN
Basic static load rating, Co	9,790 kN