

## CFE 20 UU IKO

Cam followers

TYPE: Roller bearings, Stud type track rollers, With axial guidance, with eccentric collar, sealing rings on both sides, cylindrical outer ring

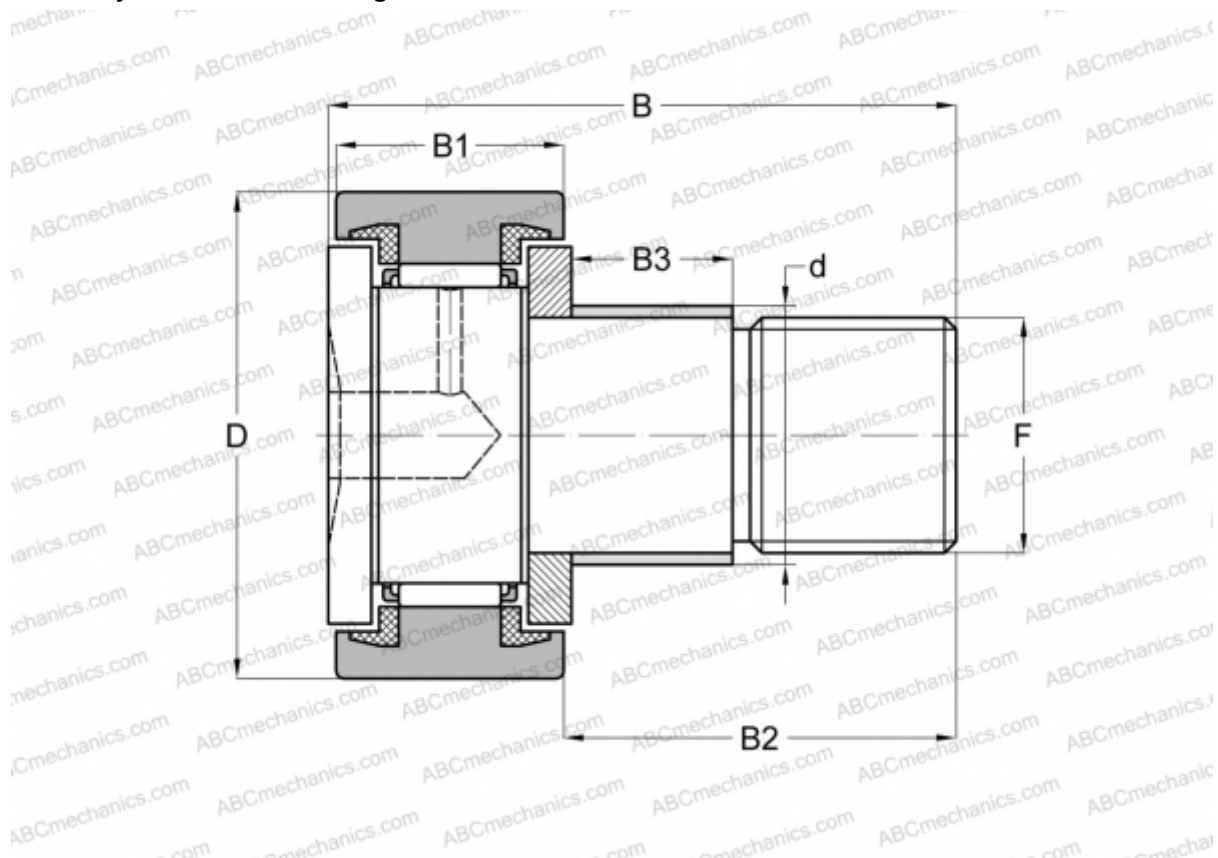

### Technical specification

#### DIMENSIONS, MM

d	27,000
D	52,000
B	66,100
B1	24,000
B2	40,500
F	M20x1.5

**WEIGHT, KG** 0,500

**MANUFACTURER** [IKO](#)

#### CALCULATION DATA

Basic dynamic load rating, C	20,700 kN
Basic static load rating, Co	34,600 kN