

## CFE 24-1 UU IKO

Cam followers

TYPE: Roller bearings, Stud type track rollers, With axial guidance, with eccentric collar, sealing rings on both sides, cylindrical outer ring

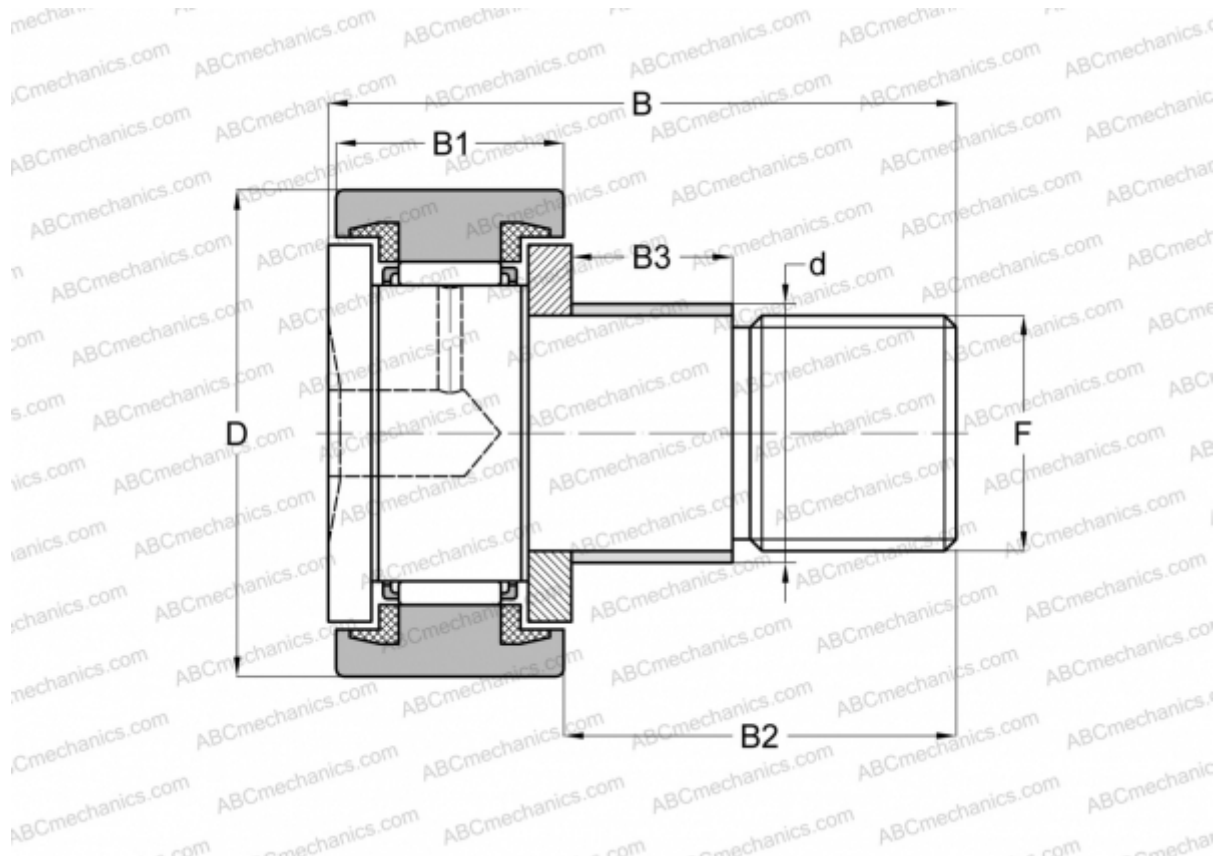

### Technical specification

#### DIMENSIONS, MM

d	33,000
D	72,000
B	80,100
B1	29,000
B2	49,500
F	M24x1.5

**WEIGHT, KG** 1,220

**MANUFACTURER** [IKO](#)

#### CALCULATION DATA

Basic dynamic load rating, C	30,500 kN
Basic static load rating, Co	52,600 kN