

CFE 30-2 UU IKO

Cam followers

TYPE: Roller bearings, Stud type track rollers, With axial guidance, with eccentric collar, sealing rings on both sides, cylindrical outer ring

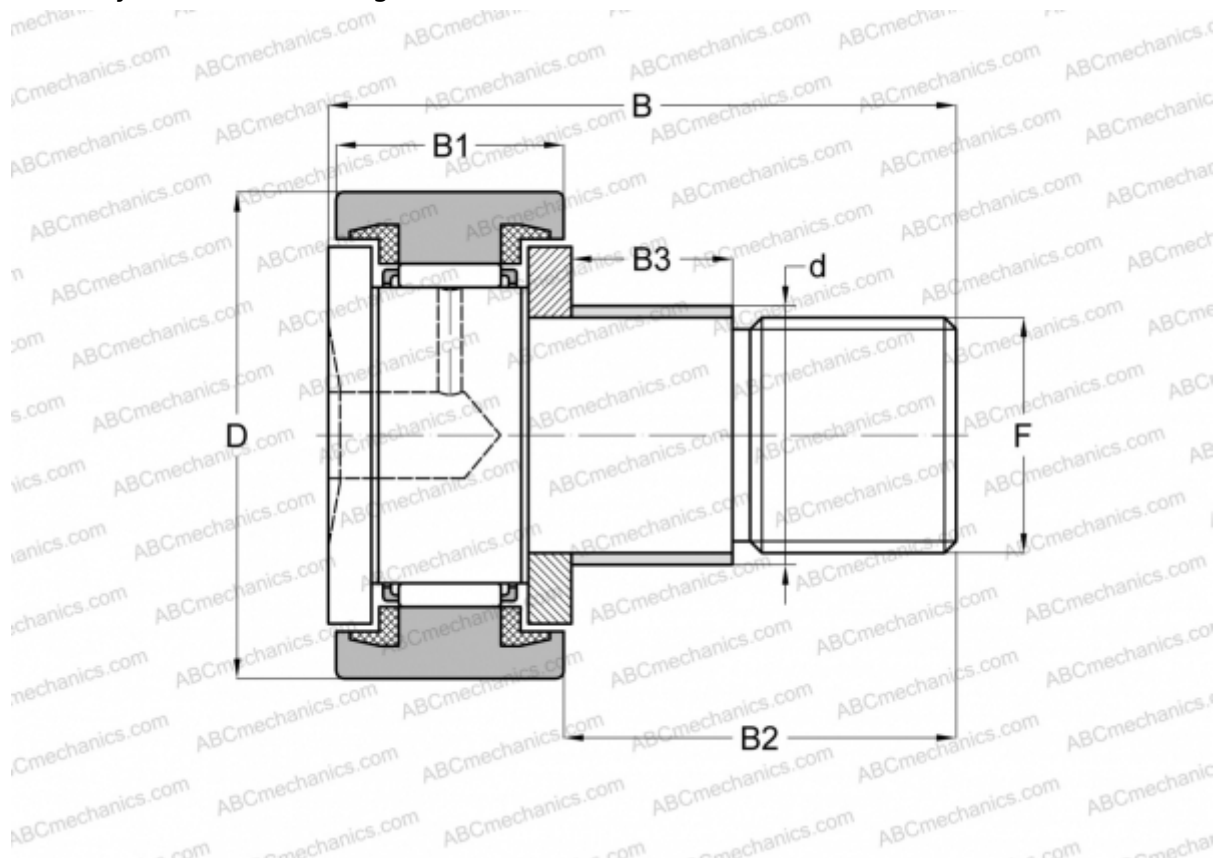

Technical specification

DIMENSIONS, MM

d	41,000
D	90,000
B	100,000
B1	35,000
B2	63,000
F	M30x1.5

WEIGHT, KG 2,380

MANUFACTURER [IKO](#)

CALCULATION DATA

Basic dynamic load rating, C	45,400 kN
Basic static load rating, Co	85,100 kN