

## CFE 10 BR IKO

Cam followers

TYPE: Roller bearings, Stud type track rollers, With axial guidance, with eccentric collar, hex socket

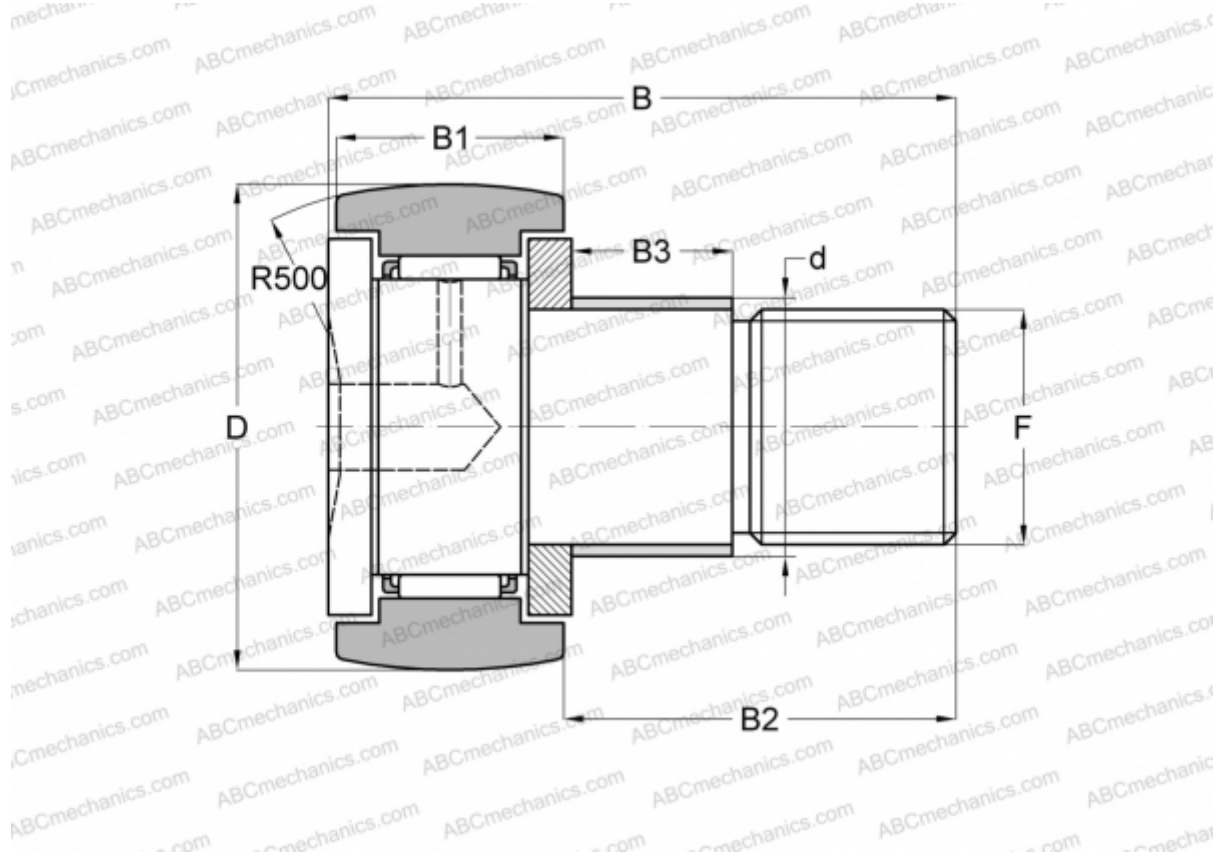

### Technical specification

#### DIMENSIONS, MM

d	13,000
D	22,000
B	36,200
B1	12,000
B2	23,000
F	M10x1.25

**WEIGHT, KG** 0,050

**MANUFACTURER** [IKO](#)

#### INTERCHANGE

ABC	<a href="#">CFE 10 BR</a>
-----	---------------------------

#### CALCULATION DATA

Basic dynamic load rating, C	5,430 kN
Basic static load rating, Co	6,890 kN