

## CFE 12 BR IKO

Cam followers

TYPE: Roller bearings, Stud type track rollers, With axial guidance, with eccentric collar, hex socket

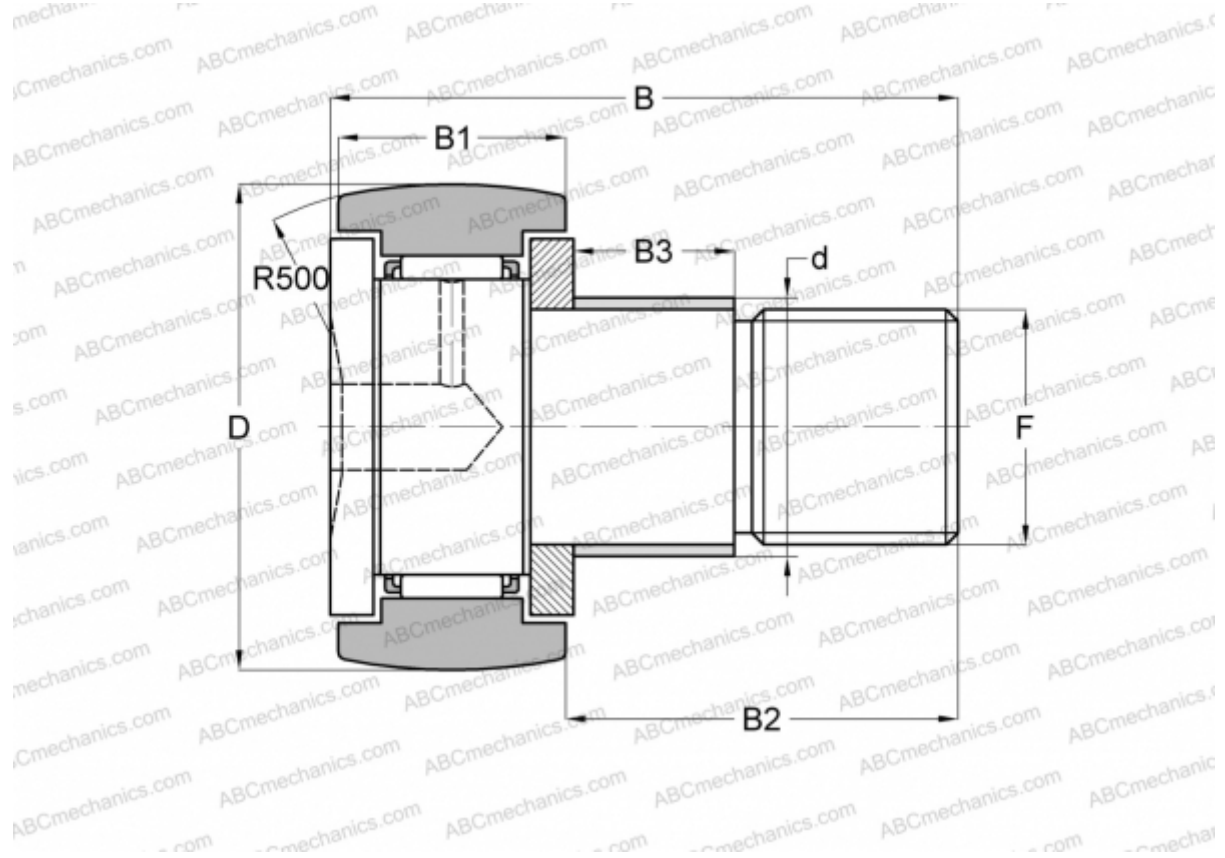

### Technical specification

#### DIMENSIONS, MM

d	16,000
D	30,000
B	40,200
B1	14,000
B2	25,000
F	M12x1.5

**WEIGHT, KG** 0,105

**MANUFACTURER** [IKO](#)

#### INTERCHANGE

ABC	<a href="#">CFE 12 BR</a>
-----	---------------------------

#### CALCULATION DATA

Basic dynamic load rating, C	7,910 kN
Basic static load rating, Co	9,790 kN