

CFE 16 BR ABC

Cam followers

TYPE: Roller bearings, Stud type track rollers, With axial guidance, with eccentric collar, hex socket

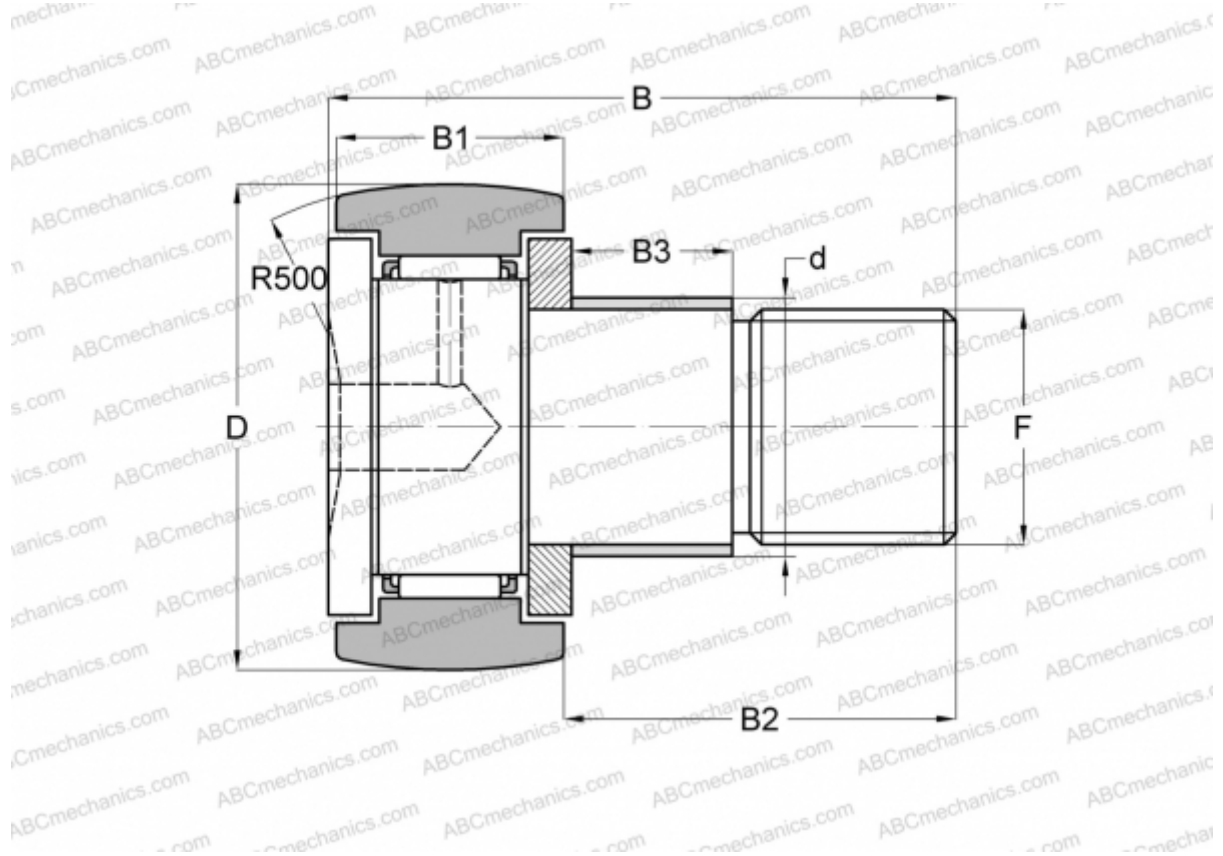

Technical specification

DIMENSIONS, MM

d	22,000
D	35,000
B	52,100
B1	18,000
B2	32,500
F	M16x1.5

WEIGHT, KG 0,190

MANUFACTURER [ABC](#)

INTERCHANGE

IKO	CFE 16 BR
-----	---------------------------