

CFE 30 BR ABC

Cam followers

TYPE: Roller bearings, Stud type track rollers, With axial guidance, with eccentric collar, hex socket

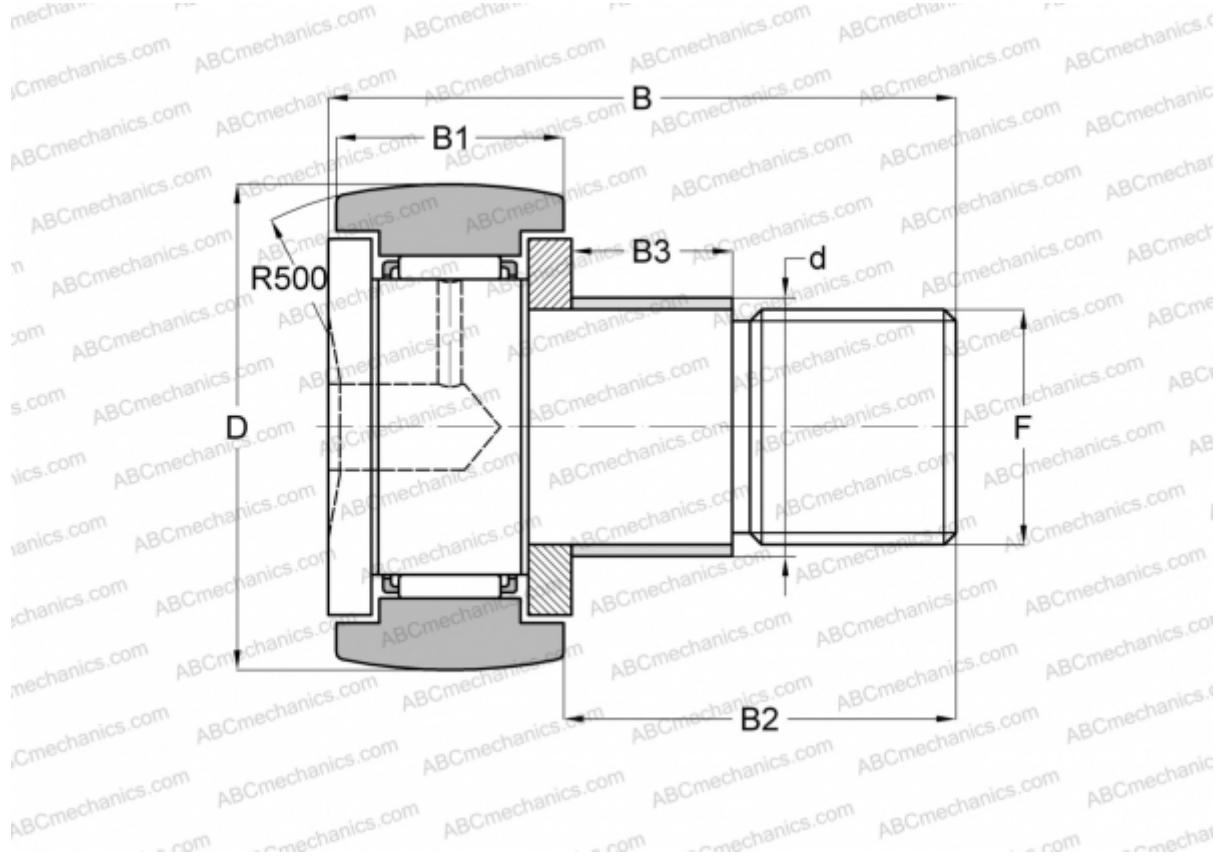

Technical specification

DIMENSIONS, MM

d	41,000
D	80,000
B	100,000
B1	35,000
B2	63,000
F	M30x1.5

WEIGHT, KG 2,030

MANUFACTURER [ABC](#)

INTERCHANGE

IKO [CFE 30 BR](#)