

CFE 10-1 B IKO

Cam followers

TYPE: Roller bearings, Stud type track rollers, With axial guidance, with eccentric collar, cylindrical outer ring, hex socket

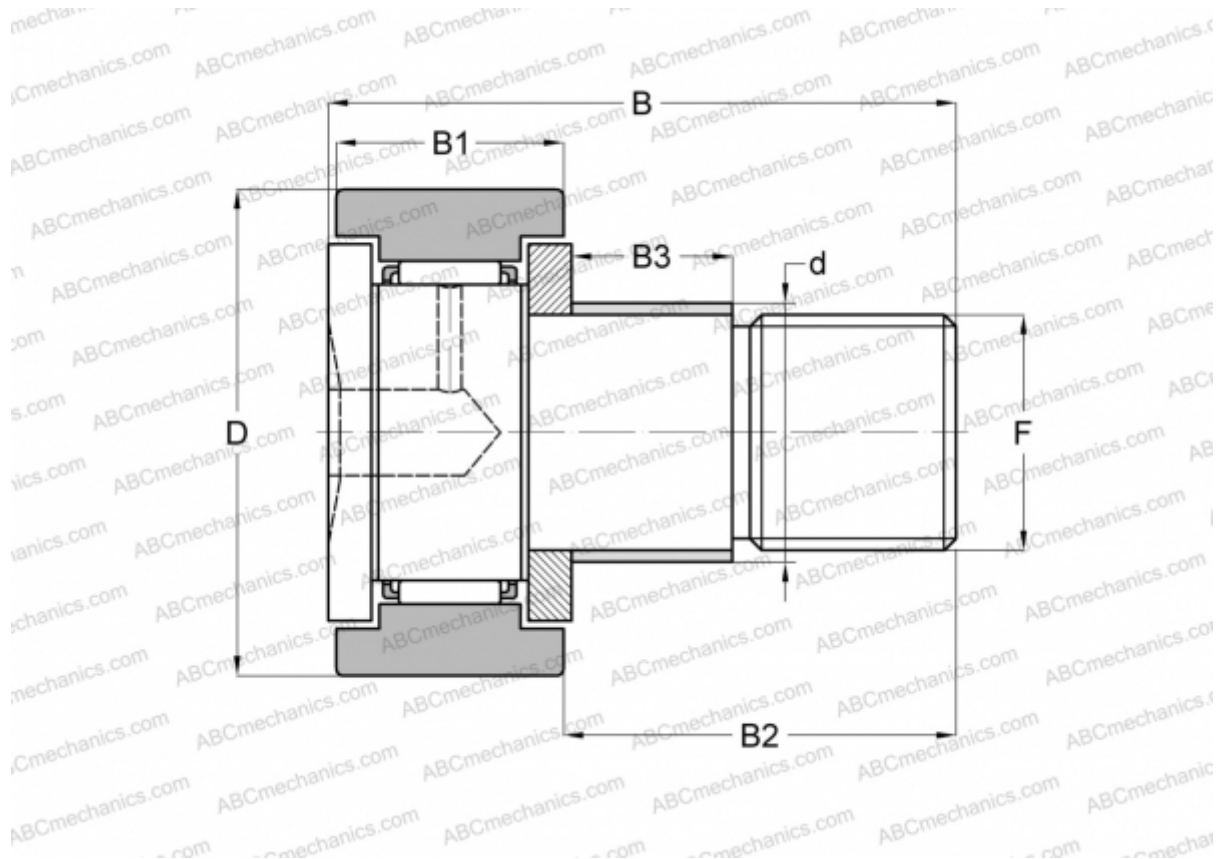

Technical specification

DIMENSIONS, MM

d	13,000
D	26,000
B	36,200
B1	12,000
B2	23,000
F	M10x1.25

WEIGHT, KG 0,065

MANUFACTURER [IKO](#)

INTERCHANGE

ABC [CFE 10-1 B](#)

CALCULATION DATA

Basic dynamic load rating, C	5,430 kN
Basic static load rating, Co	6,890 kN