

## CFE 18 B IKO

Cam followers

TYPE: Roller bearings, Stud type track rollers, With axial guidance, with eccentric collar, cylindrical outer ring, hex socket

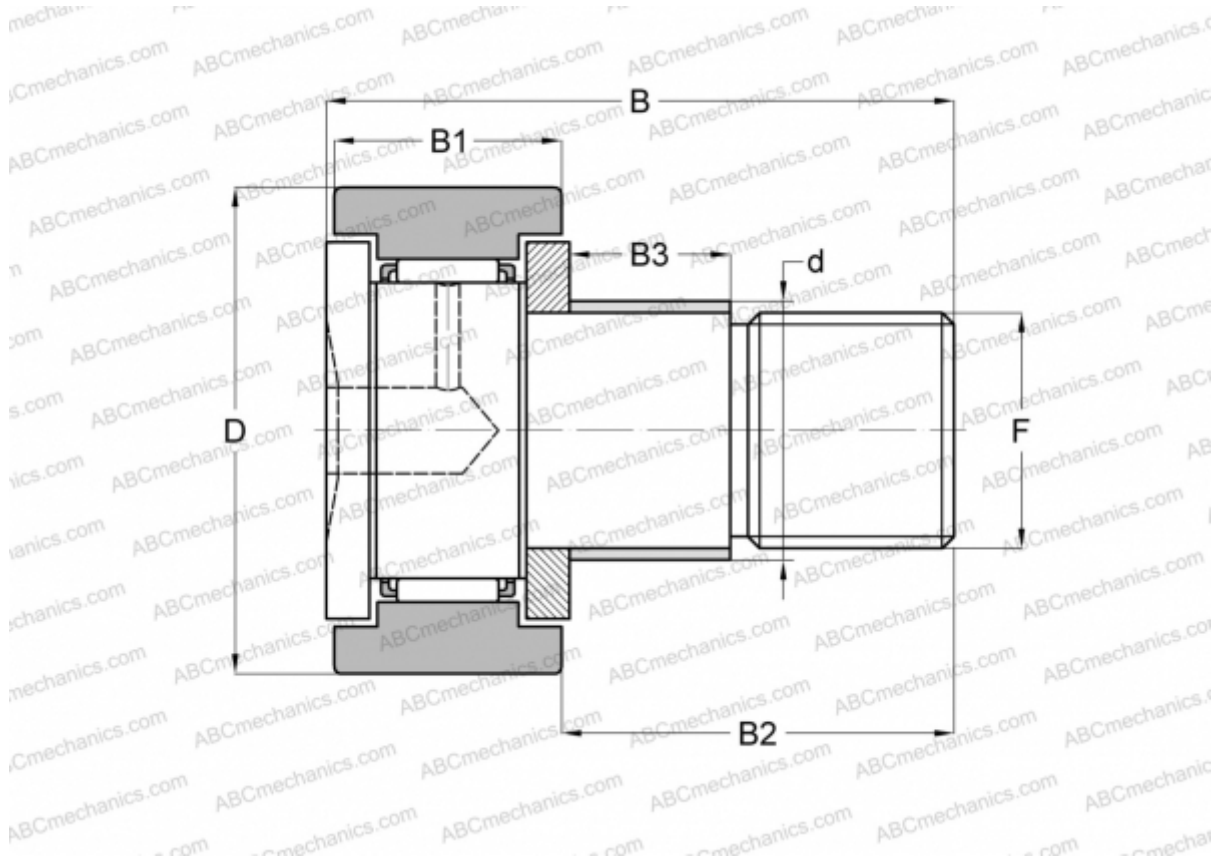

### Technical specification

#### DIMENSIONS, MM

d	24,000
D	40,000
B	58,100
B1	20,000
B2	36,500
F	M18x1.5

**WEIGHT, KG** 0,280

**MANUFACTURER** [IKO](#)

#### INTERCHANGE

ABC [CFE 18 B](#)

#### CALCULATION DATA

Basic dynamic load rating, C	14,800 kN
Basic static load rating, Co	25,200 kN