

CFE 20-1 B ABC

Cam followers

TYPE: Roller bearings, Stud type track rollers, With axial guidance, with eccentric collar, cylindrical outer ring, hex socket

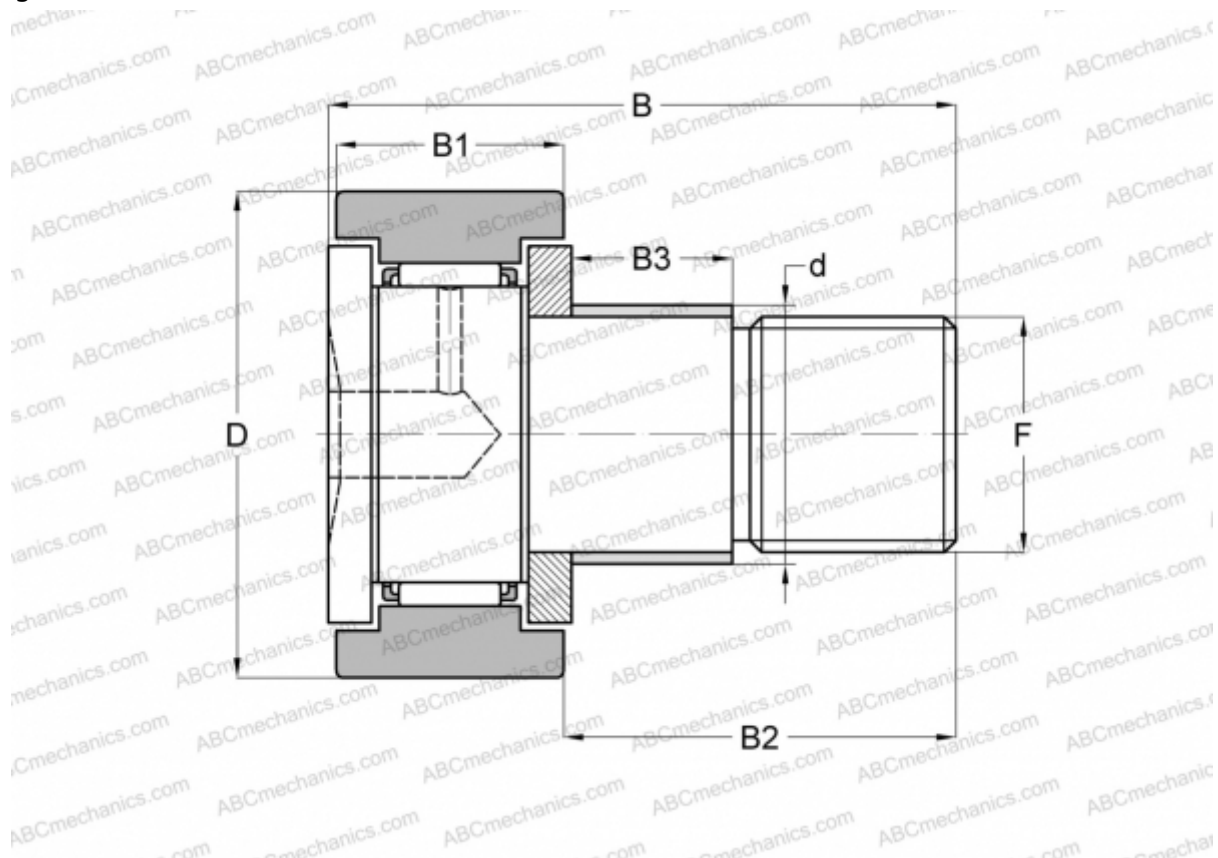

Technical specification

DIMENSIONS, MM

d	27,000
D	47,000
B	66,100
B1	24,000
B2	40,500
F	M20x1.5

WEIGHT, KG 0,425

MANUFACTURER [ABC](#)

INTERCHANGE

IKO [CFE 20-1 B](#)