

CFE 24 BUU IKO

Cam followers

TYPE: Roller bearings, Stud type track rollers, With axial guidance, with eccentric collar, sealing rings on both sides, cylindrical outer ring, hex socket

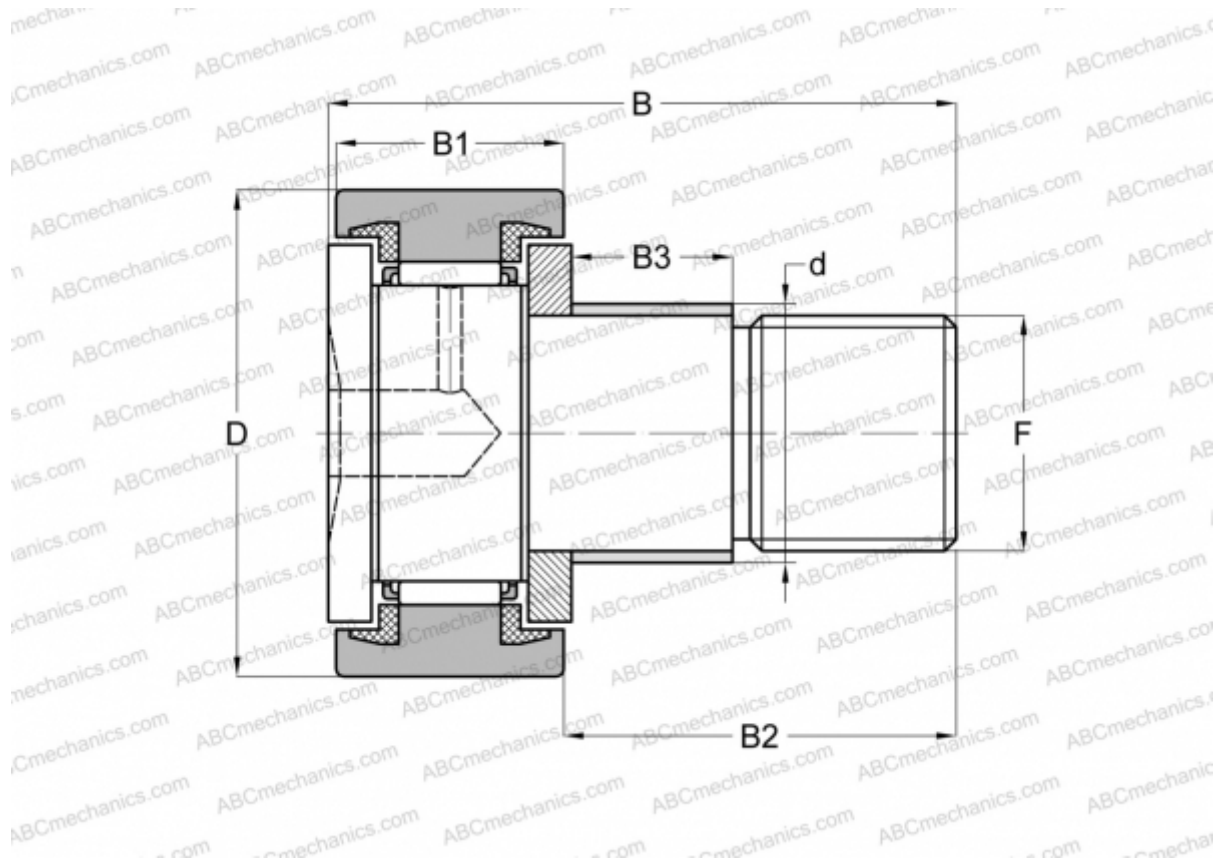

Technical specification

DIMENSIONS, MM

d	33,000
D	62,000
B	80,100
B1	29,000
B2	49,500
F	M24x1.5

WEIGHT, KG 0,895

MANUFACTURER [IKO](#)

INTERCHANGE

ABC [CFE 24 BUU](#)

CALCULATION DATA

Basic dynamic load rating, C	30,500 kN
Basic static load rating, Co	52,600 kN