

CFE 10 VR ABC

Cam followers

TYPE: Roller bearings, Stud type track rollers, With axial guidance, eccentric stud, full complement bearing, gap seal on both side

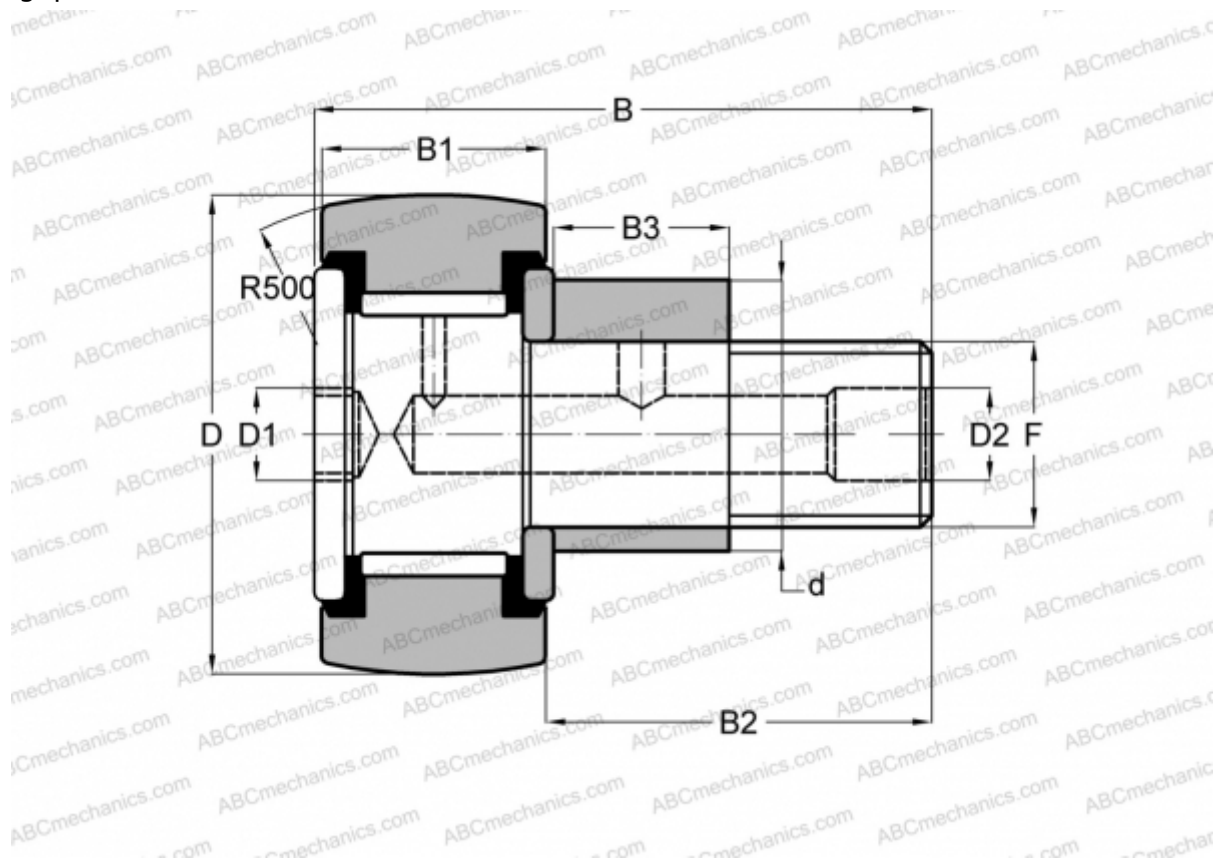

Technical specification

DIMENSIONS, MM

d	13,000
D	22,000
B	36,200
B1	12,000
B2	23,000
F	M10x1.25

WEIGHT, KG 0,051

MANUFACTURER [ABC](#)

INTERCHANGE

IKO [CFE 10 VR](#)