

CFE 16 VR ABC

Cam followers

TYPE: Roller bearings, Stud type track rollers, With axial guidance, eccentric stud, full complement bearing, gap seal on both side

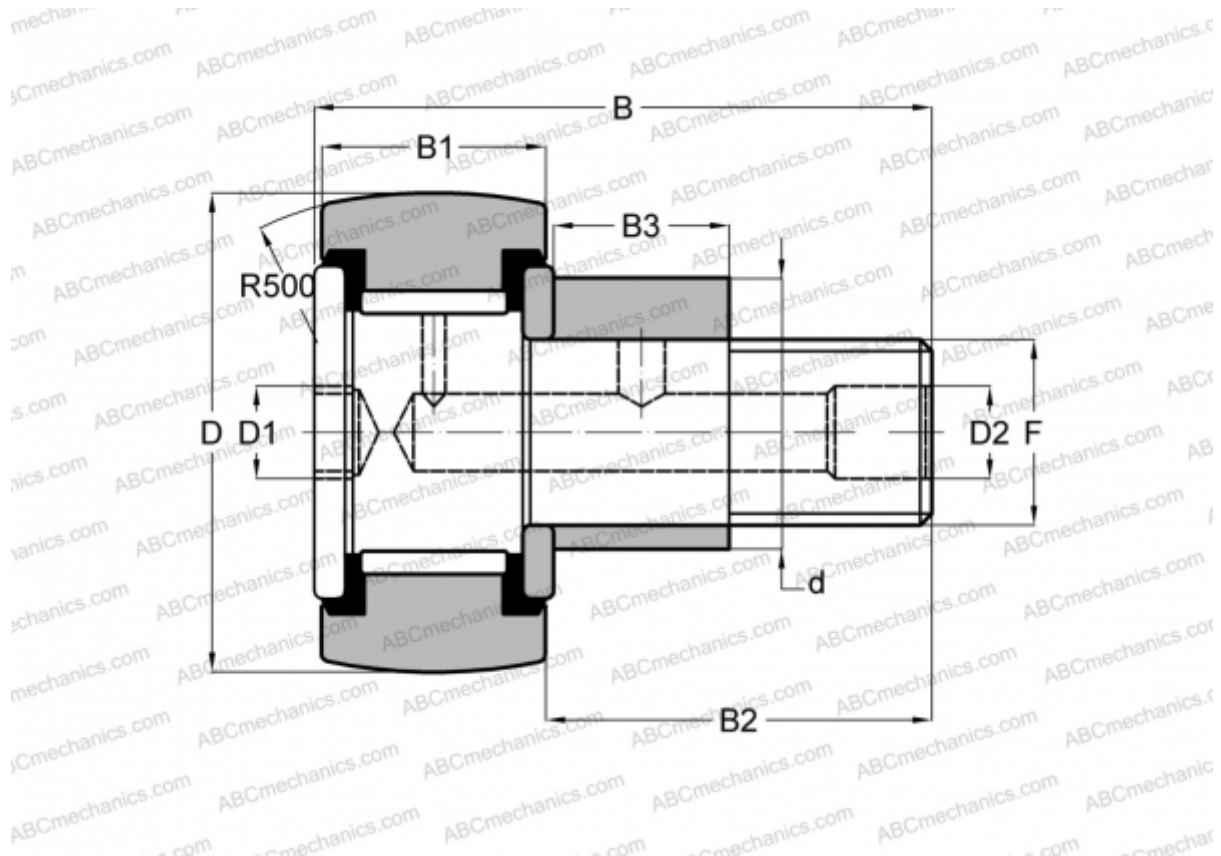

Technical specification

DIMENSIONS, MM

| | |
|----|---------|
| d | 22,000 |
| D | 35,000 |
| B | 52,100 |
| B1 | 18,000 |
| B2 | 32,500 |
| F | M16x1.5 |

WEIGHT, KG 0,193

MANUFACTURER [ABC](#)

INTERCHANGE

IKO [CFE 16 VR](#)