

CFE 16 VR IKO

Cam followers

TYPE: Roller bearings, Stud type track rollers, With axial guidance, eccentric stud, full complement bearing, gap seal on both side

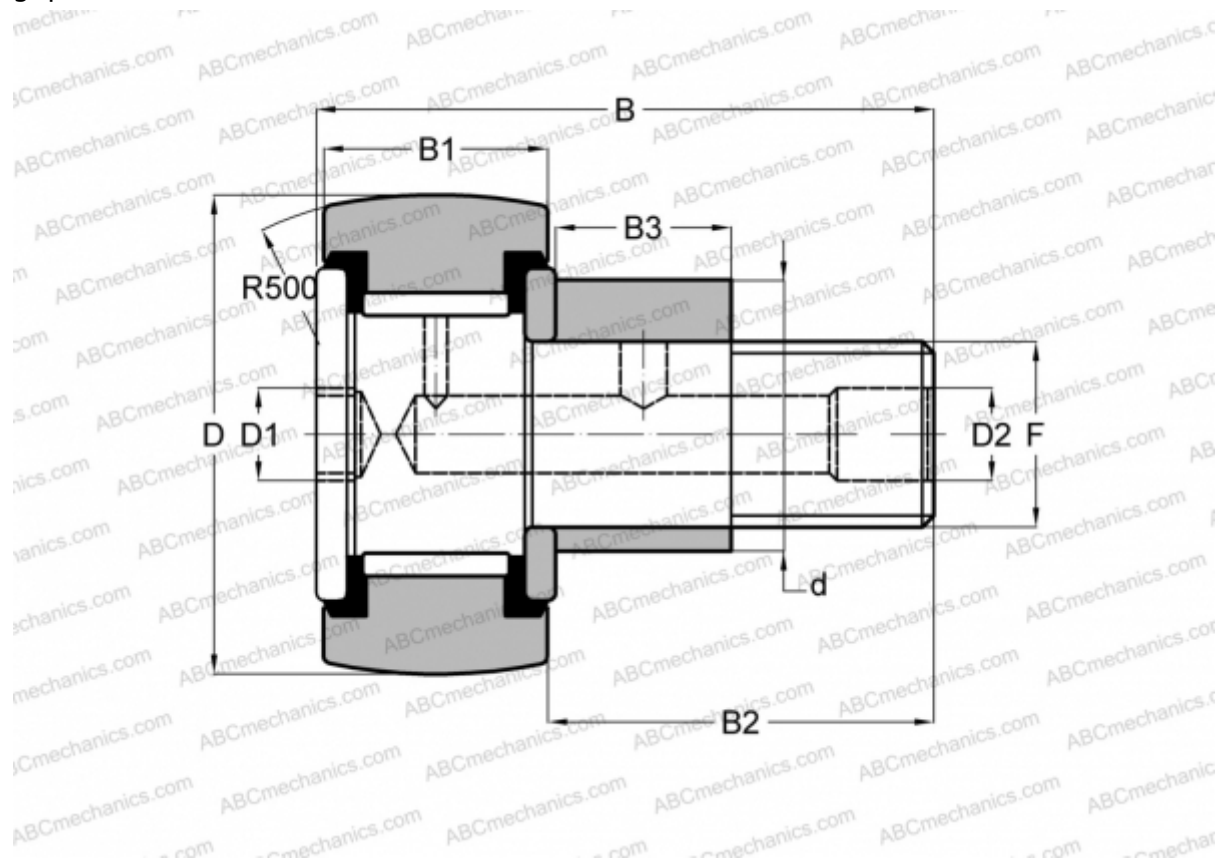

Technical specification

DIMENSIONS, MM

d	22,000
D	35,000
B	52,100
B1	18,000
B2	32,500
F	M16x1.5

WEIGHT, KG 0,193

MANUFACTURER [IKO](#)

INTERCHANGE

ABC [CFE 16 VR](#)

CALCULATION DATA

Basic dynamic load rating, C	20,700 kN
Basic static load rating, Co	37,600 kN