

CFE 30-1 VR ABC

Cam followers

TYPE: Roller bearings, Stud type track rollers, With axial guidance, eccentric stud, full complement bearing, gap seal on both side

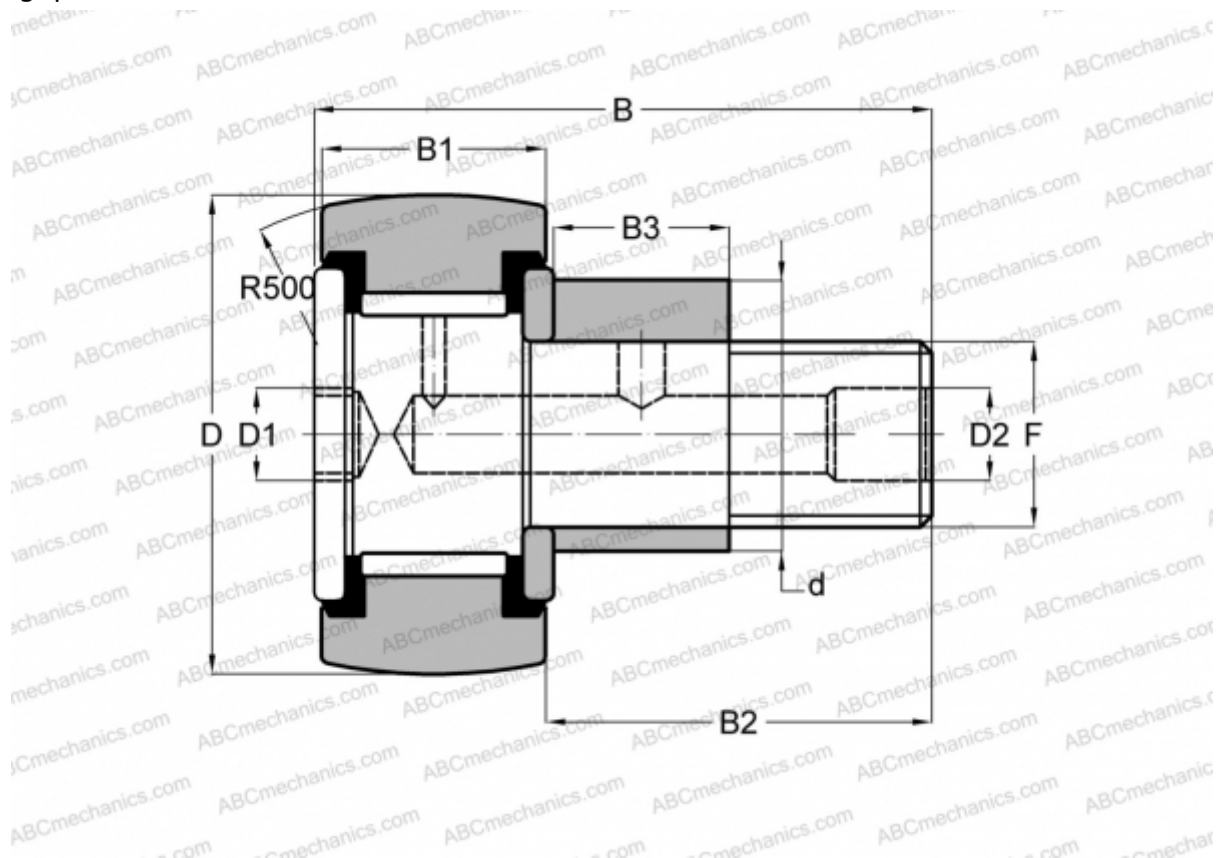

Technical specification

DIMENSIONS, MM

d	41,000
D	85,000
B	100,000
B1	35,000
B2	63,000
F	M30x1.5

WEIGHT, KG 2,190

MANUFACTURER [ABC](#)

INTERCHANGE

IKO [CFE 30-1 VR](#)