

CFE 12-1 VUUR ABC

Cam followers

TYPE: Roller bearings, Stud type track rollers, With axial guidance, eccentric stud, full complement bearing, gap seal on both side, gap seal on both side

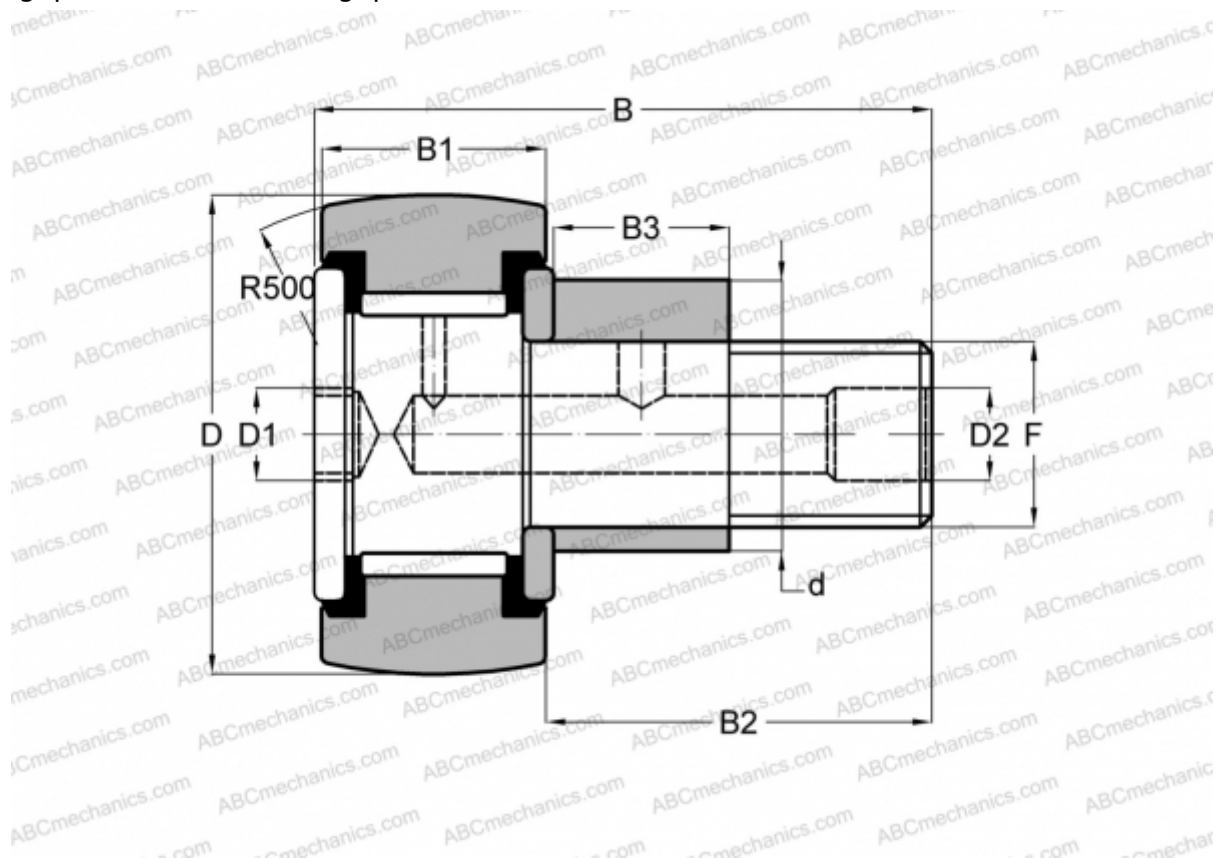

Technical specification

DIMENSIONS, MM

d	16,000
D	32,000
B	40,200
B1	14,000
B2	25,000
F	M12x1.5

WEIGHT, KG 0,117

MANUFACTURER [ABC](#)

INTERCHANGE

IKO [CFE 12-1 VUUR](#)