

CFE 24 VUUR IKO

Cam followers

TYPE: Roller bearings, Stud type track rollers, With axial guidance, eccentric stud, full complement bearing, gap seal on both side, gap seal on both side

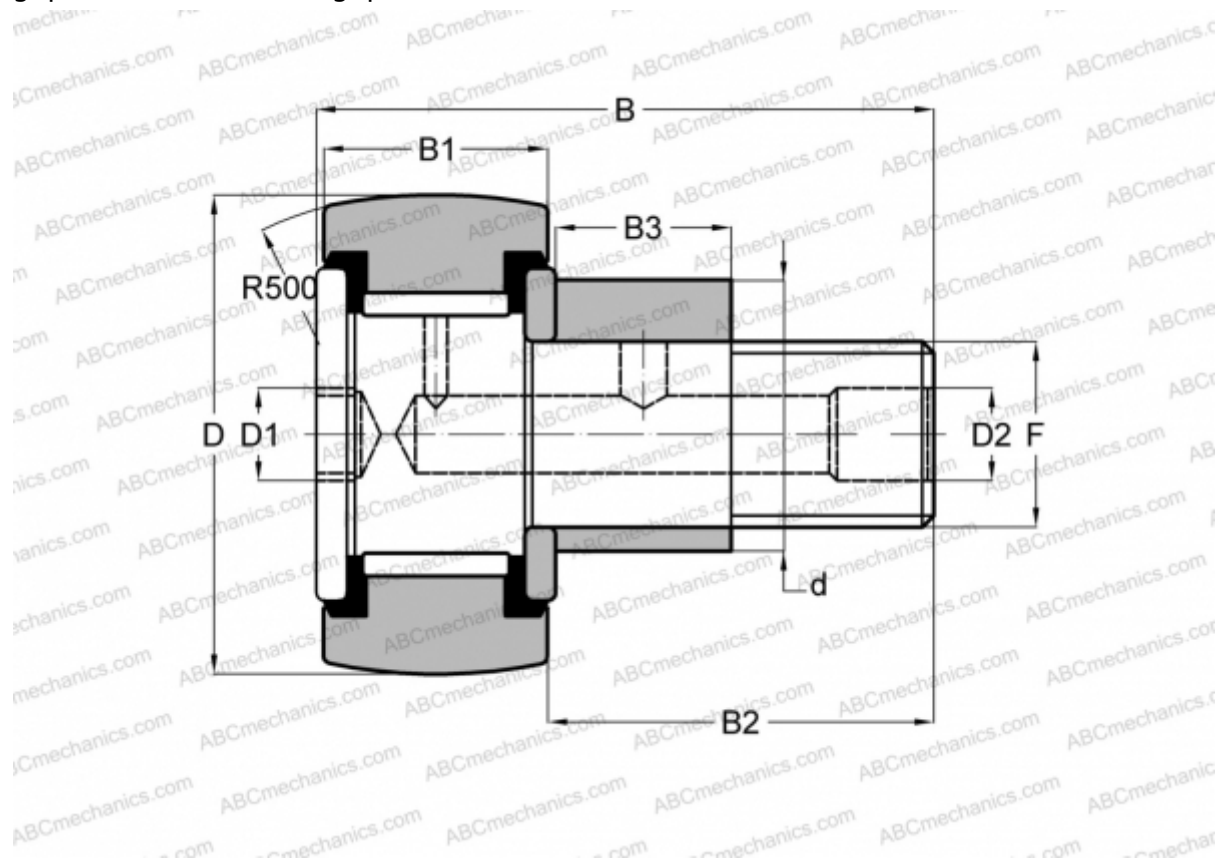

Technical specification

DIMENSIONS, MM

d	33,000
D	62,000
B	80,100
B1	29,000
B2	49,500
F	M24x1.5

WEIGHT, KG 0,900

MANUFACTURER [IKO](#)

INTERCHANGE

ABC [CFE 24 VUUR](#)

CALCULATION DATA

Basic dynamic load rating, C	46,600 kN
Basic static load rating, Co	92,000 kN