

CFE 18 VBUU ABC

Cam followers

TYPE: Roller bearings, Stud type track rollers, With axial guidance, eccentric stud, full complement bearing, sealing rings on both sides, cylindrical outer ring

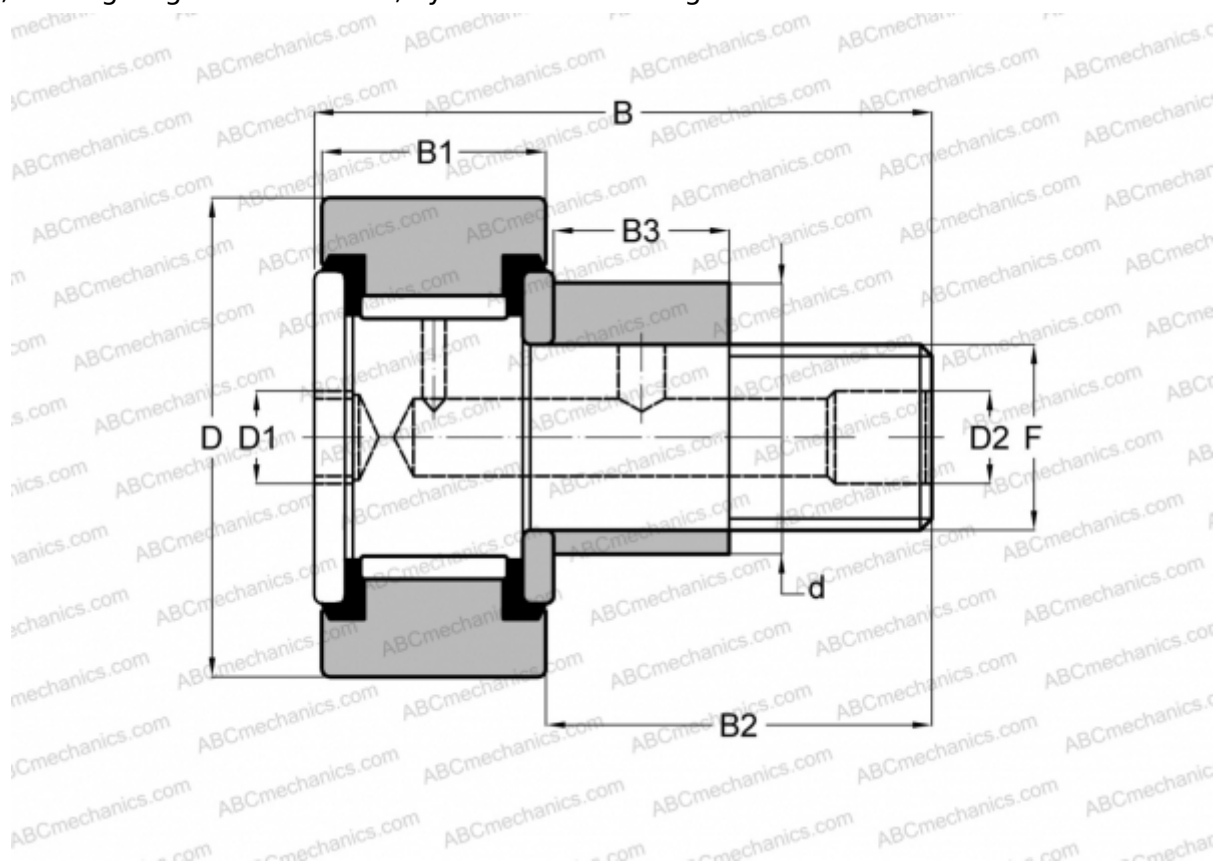

Technical specification

DIMENSIONS, MM

d	24,000
D	40,000
B	58,100
B1	20,000
B2	36,500
F	M18x1.5

WEIGHT, KG 0,285

MANUFACTURER [ABC](#)

INTERCHANGE

IKO [CFE 18 VBUU](#)