

CF 10-1 WBUUR IKO

Cam followers

TYPE: Roller bearings, Stud type track rollers, With axial guidance, sealing rings on both sides, thrust disk type, hex hole

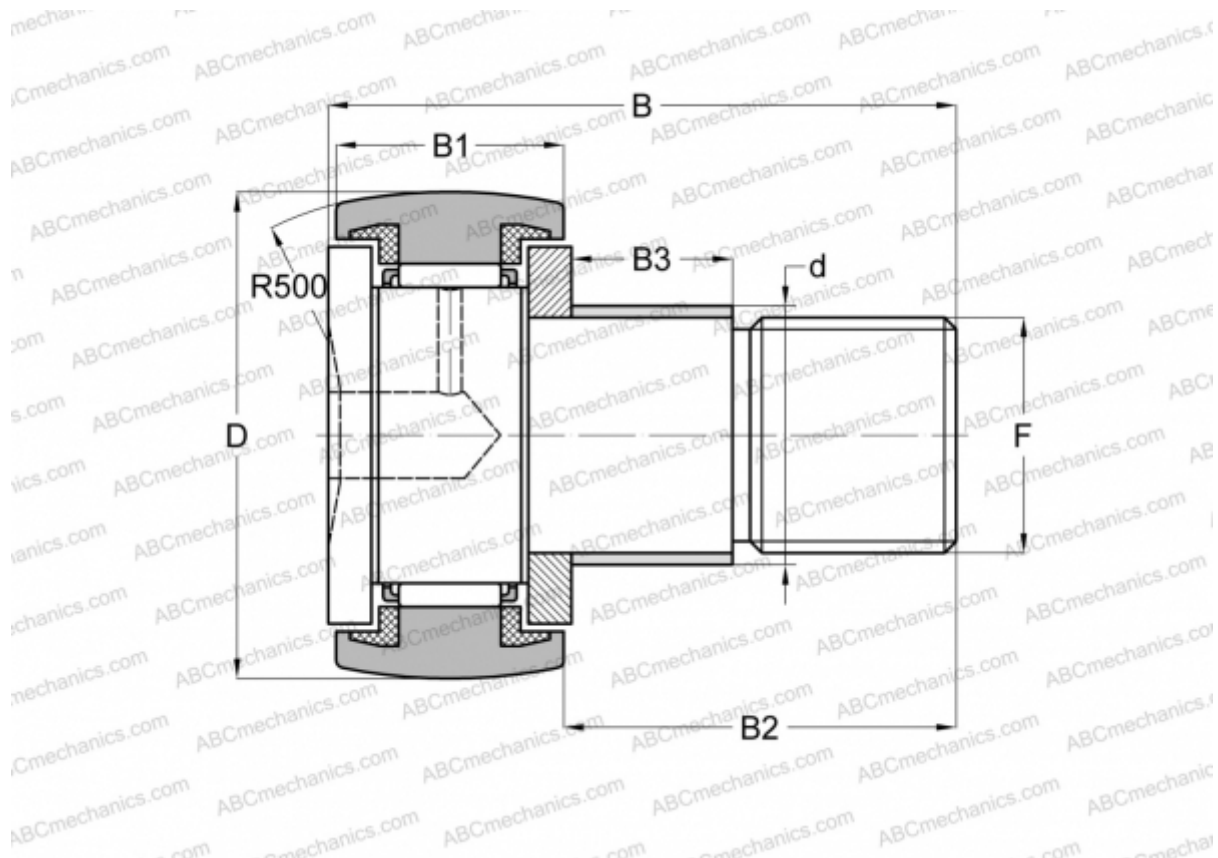

Technical specification

DIMENSIONS, MM

d	10,000
D	26,000
B	36,200
B1	12,000
B2	23,000
F	M10x1.25

WEIGHT, KG 0,060

MANUFACTURER [IKO](http://www.iko.com)

CALCULATION DATA

Basic dynamic load rating, C	5,430 kN
Basic static load rating, Co	6,890 kN