

CF 20 WBUUR IKO

Cam followers

TYPE: Roller bearings, Stud type track rollers, With axial guidance, sealing rings on both sides, thrust disk type, hex hole

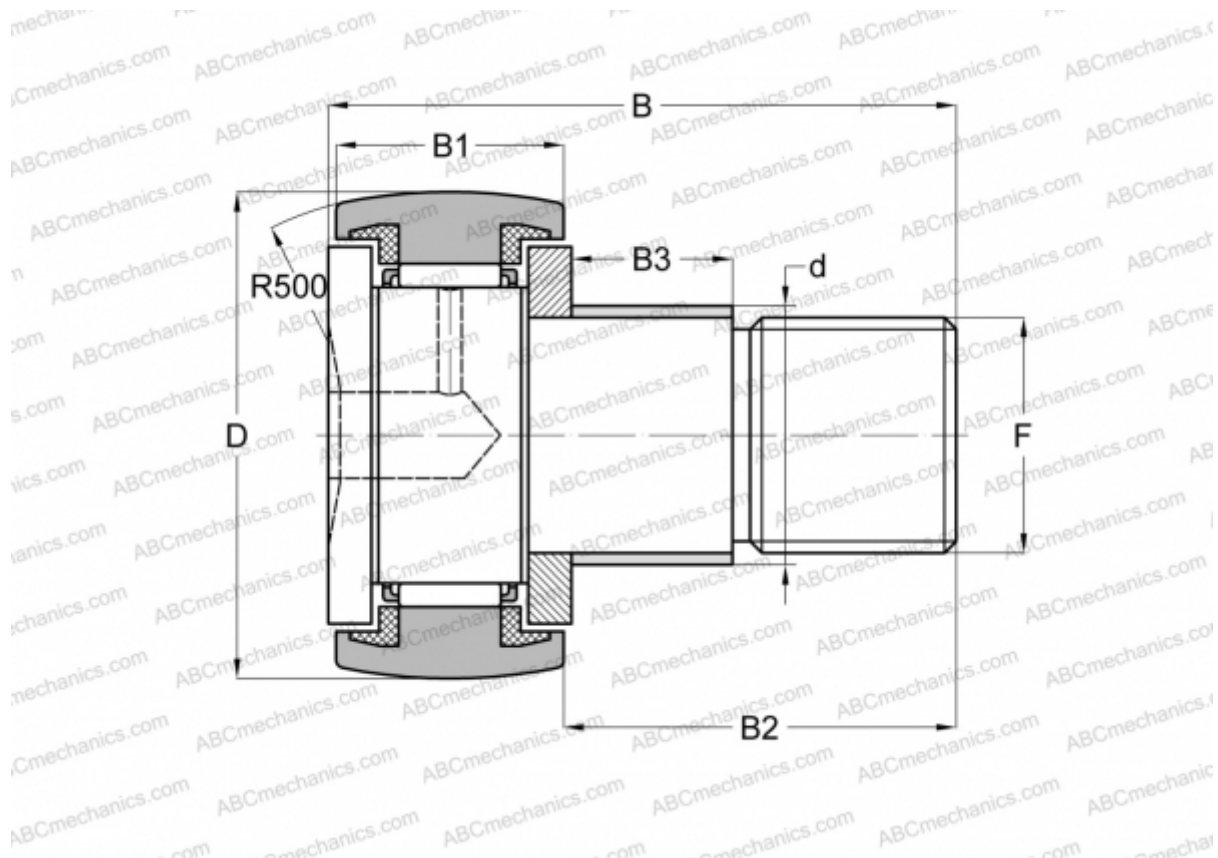

Technical specification

DIMENSIONS, MM

d	20,000
D	52,000
B	66,100
B1	24,000
B2	40,500
F	M20x1.5

WEIGHT, KG 0,460

MANUFACTURER [IKO](http://www.iko.com)

CALCULATION DATA

Basic dynamic load rating, C	20,700 kN
Basic static load rating, Co	34,600 kN